



Bardac ***drives***



PL / PLX Digital DC Drive

Part 2 Application Blocks

HG501442

v5.15h

Part 1
Basic
Product Manual

Part 2
Application Blocks

Part 3
High Power Modules

Bardac *drives*



NOTE. These instructions do not purport to cover all details or variations in equipment, or to provide for every possible contingency to be met in connection with installation, operation, or maintenance. Should further information be desired or should particular problems arise which are not covered sufficiently for the purchaser's purposes, the matter should be referred to the local Supplier sales office. The contents of this instruction manual shall not become part of or modify any prior or existing agreement, commitment, or relationship. The sales contract contains the entire obligation of Bardac Corporation. The warranty contained in the contract between the parties is the sole warranty of Bardac Corporation. Any statements contained herein do not create new warranties or modify the existing warranty.

IMPORTANT MESSAGE

This is a version 5.15 applications manual. Units with software version 5.17 upwards contain all the functions described.

Part 2 Application Blocks describes the application blocks available in the PL/X.

The application blocks are normally dormant and may be activated by using the GOTO function. Please refer to section **13 CONFIGURATION** in the main manual.

The application blocks consist of various inputs, processing functions and outputs that are found to be useful in typical industrial motion control and process industries.

There is a self contained unit called the PLA which is available. It contains all of the applications blocks described, plus I/O and comms facilities. It is intended for general purposes signal processing. See the PLA manual available on www.sprint-electric.com

1 Table of contents

1	Table of contents.....	3
2	Warnings	7
2.1	General Warnings	7
2.2	Warnings and Instructions	8
2.3	General Risks	9
3	APPLICATION BLOCKS	11
3.1	General rules.....	11
3.1.1	Sample times.....	11
3.1.2	Order of processing	12
3.1.3	Logic levels	12
3.1.4	Activating blocks	12
3.1.5	CONFLICT HELP MENU	12
3.2	APPLICATION BLOCKS / SUMMER 1, 2	14
3.2.1	SUMMER 1, 2 / Block diagram	15
3.2.2	SUMMER 1, 2 / Total output monitor PIN 401 / 415	15
3.2.3	SUMMER 1, 2 / Sign 1 PIN 402 / 416.....	15
3.2.4	SUMMER 1, 2 / Sign 2 PIN 403 / 417.....	16
3.2.5	SUMMER 1, 2 / Ratio 1 PIN 404 / 418.....	16
3.2.6	SUMMER 1, 2 / Ratio 2 PIN 405 / 419.....	16
3.2.7	SUMMER 1, 2 / Divider 1 PIN 406 / 420	16
3.2.8	SUMMER 1, 2 / Divider 2 PIN 407 / 421	16
3.2.9	SUMMER 1, 2 / Input 1 PIN 408 / 422.....	17
3.2.10	SUMMER 1, 2 / Input 2 PIN 409 / 423.....	17
3.2.11	SUMMER 1, 2 / Input 3 PIN 410 / 424.....	17
3.2.12	SUMMER 1, 2 / Deadband PIN 411 / 425	17

3.2.13	SUMMER 1, 2 / Output sign inverter	PIN 412 / 426	17
3.2.14	SUMMER 1, 2 / Symmetrical clamp	PIN 413 / 427	18
3.3	APPLICATION BLOCKS / PID 1, 2		19
3.3.1	PID 1, 2 / Block diagram		20
3.3.2	PID 1, 2 / PID output monitor	PIN 429 / 452	21
3.3.3	PID 1, 2 / PID IP1 value	PIN 430 / 453	21
3.3.4	PID 1, 2 / PID IP1 ratio	PIN 431 / 454	21
3.3.5	PID 1, 2 / PID IP1 divider	PIN 432 / 455	21
3.3.6	PID 1, 2 / PID IP2 value	PIN 433 / 456	21
3.3.7	PID 1, 2 / PID IP2 ratio	PIN 434 / 457	22
3.3.8	PID 1, 2 / PID IP2 divider	PIN 435 / 458	22
3.3.9	PID 1, 2 / PID proportional gain	PIN 436 / 459	22
3.3.10	PID 1, 2 / PID integrator time constant	PIN 437 / 460	22
3.3.11	PID 1, 2 / PID derivative time constant	PIN 438 / 461	23
3.3.12	PID 1, 2 / PID derivative filter time constant	PIN 439 / 462	23
3.3.13	PID 1, 2 / PID integrator preset	PIN 440 / 463	23
3.3.14	PID 1, 2 / PID integrator preset value	PIN 441 / 464	23
3.3.15	PID 1, 2 / PID reset	PIN 442 / 465	24
3.3.16	PID 1, 2 / PID positive clamp level	PIN 443 / 466	24
3.3.17	PID 1, 2 / PID negative clamp level	PIN 444 / 467	24
3.3.18	PID 1, 2 / PID output % trim	PIN 445 / 468	24
3.3.19	PID 1, 2 / PID profile mode select	PIN 446 / 469	25
3.3.20	PID 1, 2 / PID minimum proportional gain	PIN 447 / 470	25
3.3.21	PID 1, 2 / PID Profile X axis minimum	PIN 448 / 471	25
3.3.22	PID 1, 2 / PID Profile X axis GET FROM		26
3.3.23	PID 1, 2 / PID Profiled prop gain output monitor	PIN 449 / 472	26
3.3.24	PID 1, 2 / PID clamp flag monitor	PIN 450 / 473	26
3.3.25	PID 1, 2 / PID error value monitor	PIN 451 / 474	26
3.4	APPLICATION BLOCKS / PARAMETER PROFILER		27
3.4.1	PARAMETER PROFILER / Block diagram		27
3.4.1.1	Profile for Y increasing with X		27
3.4.1.2	Profile for Y decreasing with X		28
3.4.1.3	Examples of general profiles		28
3.4.2	PARAMETER PROFILER / Profile Y output monitor	PIN 475	29
3.4.3	PARAMETER PROFILER / Profiler mode	PIN 476	29
3.4.4	PARAMETER PROFILER / Profile Y at Xmin	PIN 477	29
3.4.5	PARAMETER PROFILER / Profiler Y at Xmax	PIN 478	29
3.4.6	PARAMETER PROFILER / Profile X axis minimum	PIN 479	30
3.4.7	PARAMETER PROFILER / Profile X axis maximum	PIN 480	30
3.4.8	PARAMETER PROFILER / Profile X axis rectify	PIN 481	30
3.4.9	PARAMETER PROFILER / Profile X axis GET FROM		30
3.5	APPLICATION BLOCKS / REEL DIAMETER CALC		31
3.5.1	REEL DIAMETER CALC / Block diagram		32
3.5.2	REEL DIAMETER CALC / Diameter output monitor	PIN 483	32
3.5.3	REEL DIAMETER CALC / Web speed input	PIN 484	32
3.5.4	REEL DIAMETER CALC / Reel speed input	PIN 485	32
3.5.5	REEL DIAMETER CALC / Minimum diameter input	PIN 486	33
3.5.6	REEL DIAMETER CALC / Diameter calculation min speed	PIN 487	33
3.5.7	REEL DIAMETER CALC / Diameter hold enable	PIN 488	33
3.5.8	REEL DIAMETER CALC / Diameter filter time constant	PIN 489	33
3.5.9	REEL DIAMETER CALC / Diameter preset enable	PIN 490	34
3.5.10	REEL DIAMETER CALC / Diameter preset value	PIN 491	34
3.5.11	REEL DIAMETER CALC / Diameter web break threshold	PIN 492	34
3.5.12	REEL DIAMETER CALC / Diameter memory boot up	PIN 493	34
3.6	APPLICATION BLOCKS / TAPER TENSION CALC		35
3.6.1	TAPER TENSION CALC / Block diagram		35
3.6.1.1	Linear taper equation		35
3.6.1.2	Hyperbolic taper equation		35

3.6.1.3	Taper graphs showing tension versus diameter	36
3.6.1.4	Taper graphs showing torque versus diameter.....	36
3.6.2	TAPER TENSION CALC / Total tension OP monitor PIN 494	36
3.6.3	TAPER TENSION CALC / Tension reference PIN 495	36
3.6.4	TAPER TENSION CALC / Taper strength input PIN 496	37
3.6.5	TAPER TENSION CALC / Hyperbolic taper enable PIN 497	37
3.6.6	TAPER TENSION CALC / Tension trim input PIN 498.....	37
3.6.7	TAPER TENSION CALC / Tapered tension monitor PIN 499	37
3.7	APPLICATION BLOCKS / TORQUE COMPENSATOR	38
3.7.1	TORQUE COMPENSATOR / Block diagram.....	39
3.7.2	TORQUE COMPENSATOR / Torque demand monitor PIN 500.....	40
3.7.3	TORQUE COMPENSATOR / Torque trim input PIN 501	40
3.7.4	TORQUE COMPENSATOR / Stiction compensation PIN 502	40
3.7.5	TORQUE COMPENSATOR / Stiction web speed threshold PIN 503.....	40
3.7.6	TORQUE COMPENSATOR / Static friction compensation PIN 504	41
3.7.7	TORQUE COMPENSATOR / Dynamic friction compensation PIN 505	41
3.7.8	TORQUE COMPENSATOR / Friction sign PIN 506	42
3.7.9	TORQUE COMPENSATOR / Fixed mass inertia PIN 507	42
3.7.10	TORQUE COMPENSATOR / Variable mass inertia PIN 508	42
3.7.11	TORQUE COMPENSATOR / Material width PIN 509	43
3.7.12	TORQUE COMPENSATOR / Accel line speed input PIN 510	43
3.7.13	TORQUE COMPENSATOR / Accel scaler PIN 511	44
3.7.14	TORQUE COMPENSATOR / Accel input/monitor PIN 512.....	44
3.7.15	TORQUE COMPENSATOR / Accel filter time constant PIN 513.....	44
3.7.16	TORQUE COMPENSATOR / Tension demand input PIN 514	44
3.7.17	TORQUE COMPENSATOR / Tension scaler PIN 515.....	45
3.7.18	TORQUE COMPENSATOR / Torque memory select PIN 516.....	45
3.7.19	TORQUE COMPENSATOR / Torque memory input PIN 517	45
3.7.20	TORQUE COMPENSATOR / Tension enable PIN 518	45
3.7.21	TORQUE COMPENSATOR / Overwind/underwind PIN 519	46
3.7.22	TORQUE COMPENSATOR / Inertia comp monitor PIN 520	46
3.8	Centre winding block arrangement.....	47
3.9	APPLICATION BLOCKS / PRESET SPEED	48
3.9.1	PRESET SPEED / Block diagram.....	49
3.9.2	PRESET SPEED / Preset speed output monitor PIN 523.....	50
3.9.3	PRESET SPEED / Select bit inputs 1 lsb, 2, 3 msb PINs 524 / 525 / 526	50
3.9.4	PRESET SPEED / OP value of 000 to 111 PINs 527 to 534.....	50
3.10	APPLICATION BLOCKS / MULTI-FUNCTION 1 to 8	51
3.10.1	MULTI-FUNCTION / Block diagram.....	51
3.10.2	MULTI-FUNCTION 1 to 8 / Function mode PINs 544/6/8, 550/2/4/6/8	52
3.10.2.1	Sample and hold function.....	52
3.10.3	MULTI-FUNCTION 1 to 8 / Output select 1 to 8 PIN 545/7/9, 551/3/5/7/9	52
3.10.4	MULTI-FUNCTION 1 to 8 / Main input GET FROM 1 to 8	52
3.10.5	MULTI-FUNCTION 1 to 8 / Aux input GET FROM 1 to 8	53
3.10.6	MULTI-FUNCTION 1 to 8 / GOTO 1 to 8	53
3.11	APPLICATION BLOCKS / LATCH	54
3.11.1	LATCH / Block diagram	54
3.11.2	LATCH / Latch output monitor PIN 560.....	54
3.11.3	LATCH / Latch data input PIN 561.....	54
3.11.4	LATCH / Latch clock input PIN 562	55
3.11.5	LATCH / Latch set input PIN 563	55
3.11.6	LATCH / Latch reset input PIN 564.....	55
3.11.7	LATCH / Latch output value for HI/LOW PINs 565 / 566	55
3.12	APPLICATION BLOCKS / FILTER 1, 2	56
3.12.1	FILTER / Block diagram	56
3.12.2	FILTER 1, 2 / Filter output monitor PIN 568 / 573.....	56
3.12.3	FILTER 1, 2 / Filter time constant PIN 569 / 574	56
3.12.4	FIXED LOW PASS FILTER.....	57

3.13 APPLICATION BLOCKS / BATCH COUNTER.....	58
3.13.1 BATCH COUNTER / Block diagram	58
3.13.2 BATCH COUNTER / Counter count monitor PIN 578	58
3.13.3 BATCH COUNTER / Clock input PIN 579.....	59
3.13.4 BATCH COUNTER / Reset input PIN 580.....	59
3.13.5 BATCH COUNTER / Counter target number PIN 581	59
3.13.6 BATCH COUNTER / Count equal or greater than target flag PIN 582.....	59
3.14 APPLICATION BLOCKS / INTERVAL TIMER	60
3.14.1 INTERVAL TIMER / Block diagram	60
3.14.2 INTERVAL TIMER / Time elapsed monitor PIN 583	60
3.14.3 INTERVAL TIMER / Timer reset enable PIN 584.....	60
3.14.4 INTERVAL TIMER / Time interval setting PIN 585	61
3.14.5 INTERVAL TIMER / Timer expired flag PIN 586	61
3.15 APPLICATION BLOCKS / COMPARATOR 1 to 4	62
3.15.1 COMPARATOR 1 / Block diagram	62
3.15.2 COMPARATOR 1/2/3/4 / Input 1 PIN 588/592/596/600	62
3.15.3 COMPARATOR 1/2/3/4 / Input 2 PIN 589/593/597/601	62
3.15.4 COMPARATOR 1/2/3/4 / Window mode select PIN 590/594/598/602	63
3.15.5 COMPARATOR 1/2/3/4 / Hysteresis PIN 591/595/599/603.....	63
3.15.6 COMPARATOR 1/2/3/4 / Comparator GOTO.....	63
3.16 APPLICATION BLOCKS / C/O SWITCH 1 to 4	63
3.16.1 C/O SWITCH / Block diagram	63
3.16.1.1 C/O switch used as sample and hold function.....	64
3.16.2 C/O SWITCH 1/2/3/4 / Control PIN 604/607/610/613	64
3.16.3 C/O SWITCH 1/2/3/4 / Inputs HI/LO PIN 605/608/611/614 / 606/609/612/615	64
3.16.4 C/O SWITCH 1/2/3/4 / C/O switch GOTO	64
4 PIN table for application blocks 401 - 680.....	65
5 Index	69
6 Record of applications manual modifications.....	69
7 Record of application blocks bug fixes	70
8 Changes to product since manual publication	70

2 Warnings

2.1 General Warnings

READ AND UNDERSTAND THIS MANUAL BEFORE APPLYING POWER TO THE PL/X DRIVE UNIT

This manual describes the application blocks available in the PL/X.

The PL/X motor drive controller is an open chassis component for use in a suitable enclosure

Drives and process control systems are a very important part of creating better quality and value in the goods for our society, but they must be designed, installed and used with great care to ensure everyone's SAFETY. Remember that the equipment you will be using incorporates...

High voltage electrical equipment
Powerful rotating machinery with large stored energy
Heavy components

Your process may involve...

Hazardous materials
Expensive equipment and facilities
Interactive components

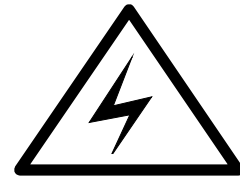

DANGER
ELECTRIC SHOCK RISK

Always use qualified personnel to design, construct and operate your systems and keep **SAFETY** as your primary concern.

Thorough personnel training is an important aid to **SAFETY** and productivity.

SAFETY awareness not only reduces the risk of accidents and injuries in your plant, but also has a direct impact on improving product quality and costs.

If you have any doubts about the **SAFETY** of your system or process, consult an expert immediately. Do not proceed without doing so.

HEALTH AND SAFETY AT WORK

Electrical devices can constitute a safety hazard. It is the responsibility of the user to ensure the compliance of the installation with any acts or bylaws in force. Only skilled personnel should install and maintain this equipment after reading and understanding this instruction manual. If in doubt refer to the supplier.

Note. The contents of this manual are believed to be accurate at the time of printing. The manufacturers, however, reserve the right to change the content and product specification without notice. No liability is accepted for omissions or errors. No liability is accepted for the installation or fitness for purpose or application of the PL/X motor drive unit.

2.2 Warnings and Instructions

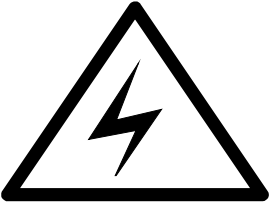

WARNING

Only qualified personnel who thoroughly understand the operation of this equipment and any associated machinery should install, start-up or attempt maintenance of this equipment. Non compliance with this warning may result in personal injury and/or equipment damage. Never work on any control equipment without first isolating all power supplies from the equipment. The drive and motor must be connected to an appropriate safety earth. Failure to do so presents an electrical shock hazard.



CAUTION

This equipment was tested before it left our factory. However, before installation and start-up, inspect all equipment for transit damage, loose parts, packing materials etc. This product conforms to IPOO protection. Due consideration should be given to environmental conditions of installation for safe and reliable operation. Never perform high voltage resistance checks on the wiring without first disconnecting the product from the circuit being tested.

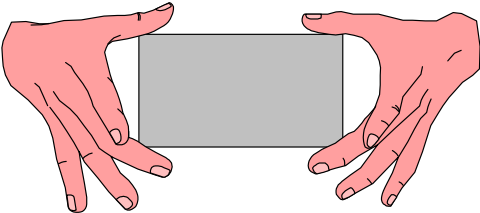

STATIC SENSITIVE

This equipment contains electrostatic discharge (ESD) sensitive parts. Observe static control precautions when handling, installing and servicing this product.

THESE WARNINGS AND INSTRUCTIONS ARE INCLUDED TO ENABLE THE USER TO OBTAIN MAXIMUM EFFECTIVENESS AND TO ALERT THE USER TO SAFETY ISSUES

APPLICATION AREA: Industrial (non-consumer) "Motor speed control utilising DC motors".

PRODUCT MANUAL: This manual is intended to provide a description of how the product works. It is not intended to describe the apparatus into which the product is installed.

This manual is to be made available to all persons who are required to design an application, install, service or come into direct contact with the product.

APPLICATIONS ADVICE: Applications advice and training is available from Bardac Corporation.

2.3 General Risks

INSTALLATION:

THIS PRODUCT IS CLASSIFIED AS A COMPONENT AND MUST BE USED IN A SUITABLE ENCLOSURE



Ensure that mechanically secure fixings are used as recommended.
 Ensure that cooling airflow around the product is as recommended.
 Ensure that cables and wire terminations are as recommended and clamped to required torque.
 Ensure that a competent person carries out the installation and commissioning of this product.
 Ensure that the product rating is not exceeded.

APPLICATION RISK:

ELECTROMECHANICAL SAFETY IS THE RESPONSIBILITY OF THE USER



The integration of this product into other apparatus or systems is not the responsibility of the manufacturer or distributor of the product.

The applicability, effectiveness or safety of operation of this equipment, or that of other apparatus or systems is not the responsibility of the manufacturer or distributor of the product.

Where appropriate the user should consider some aspects of the following risk assessment.

RISK ASSESSMENT: Under fault conditions or conditions not intended.

- | | |
|--|--------------------------------------|
| 1. The motor speed may be incorrect. | 2. The motor speed may be excessive. |
| 3. The direction of rotation may be incorrect. | 4. The motor may be energised. |

In all situations the user should provide sufficient guarding and/or additional redundant monitoring and safety systems to prevent risk of injury. NOTE: During a power loss event the product will commence a sequenced shut down procedure and the system designer must provide suitable protection for this case.

MAINTENANCE: Maintenance and repair should only be performed by competent persons using only the recommended spares (or return to factory for repair). Use of unapproved parts may create a hazard and risk of injury.



WHEN REPLACING A PRODUCT IT IS ESSENTIAL THAT ALL USER DEFINED PARAMETERS THAT DEFINE THE PRODUCT'S OPERATION ARE CORRECTLY INSTALLED BEFORE RETURNING TO USE. FAILURE TO DO SO MAY CREATE A HAZARD AND RISK OF INJURY.

PACKAGING: The packaging is combustible and if disposed of incorrectly may lead to the generation of toxic fumes, which are lethal.

WEIGHT: Consideration should be given to the weight of the product when handling.

REPAIRS: Repair reports can only be given if the user makes sufficient and accurate defect reporting.

Remember that the product without the required precautions can represent an electrical hazard and risk of injury, and that rotating machinery is a mechanical hazard.

PROTECTIVE INSULATION:

1. All exposed metal insulation is protected by basic insulation and **user** bonding to earth i.e. Class 1.
2. Earth bonding is the responsibility of the installer.
3. All signal terminals are protected by basic insulation, and the **user** earth bonding. (Class 1). The purpose of this protection is to allow safe connection to other low voltage equipment and is not designed to allow these terminals to be connected to any un-isolated potential.

3 APPLICATION BLOCKS

- 1 Table of contents.....3
- 2 Warnings 7
 - 2.1 General Warnings 7
 - 2.2 Warnings and Instructions 8
 - 2.3 General Risks 9
- 3 APPLICATION BLOCKS 11
 - 3.1 General rules..... 11
 - 3.2 APPLICATION BLOCKS / SUMMER 1, 2 14
 - 3.3 APPLICATION BLOCKS / PID 1, 2..... 19
 - 3.4 APPLICATION BLOCKS / PARAMETER PROFILER..... 27
 - 3.5 APPLICATION BLOCKS / REEL DIAMETER CALC 31
 - 3.6 APPLICATION BLOCKS / TAPER TENSION CALC 35
 - 3.7 APPLICATION BLOCKS / TORQUE COMPENSATOR 38
 - 3.8 Centre winding block arrangement 47
 - 3.9 APPLICATION BLOCKS / PRESET SPEED 48
 - 3.10 APPLICATION BLOCKS / MULTI-FUNCTION 1 to 8 51
 - 3.11 APPLICATION BLOCKS / LATCH 54
 - 3.12 APPLICATION BLOCKS / FILTER 1, 2..... 56
 - 3.13 APPLICATION BLOCKS / BATCH COUNTER 58
 - 3.14 APPLICATION BLOCKS / INTERVAL TIMER 60
 - 3.15 APPLICATION BLOCKS / COMPARATOR 1 to 4..... 62
 - 3.16 APPLICATION BLOCKS / C/O SWITCH 1 to 4..... 63
- 4 PIN table for application blocks 401 - 680 65
- 5 Index..... 69
- 6 Record of applications manual modifications 69
- 7 Record of application blocks bug fixes..... 70
- 8 Changes to product since manual publication 70

3.1 General rules

3.1.1 Sample times

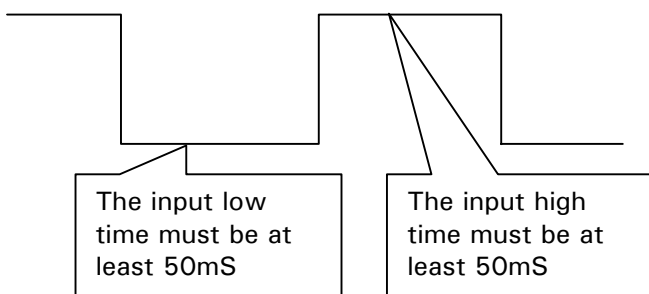

When application blocks are being processed the workload on the internal microprocessor is increased.

With no application blocks activated the time taken to perform all the necessary tasks (cycle time) is approximately 5mS.

With all the application blocks activated the cycle time is approximately 10mS. In the future, the designers expect to add even more application blocks.

It is not expected however that the typical cycle time will ever exceed 30mS. (Bear in mind that it would be highly unusual for all the application blocks to be activated).

With this in mind it is recommended that the system designer takes care that external logic signals are stable long enough to be recognised. In order to achieve this, the logic input minimum dwell time has been specified at 50mS.

It will of course be possible to operate with much lower dwell times than this for simpler installations where the cycle time is low. There is then the risk that a future re-configuration of the blocks by the user would increase the cycle time sufficiently to cause sampling problems.

3.1.2 Order of processing

It may be useful for system designers to know the order in which the blocks are processed within each cycle.

0) Analogue inputs	12) Torque compensator
1) Motorised pot	13) Zero interlocks
2) Digital inputs	14) Speed control
3) Reference exchange	15) Preset speed
4) Jumpers	16) Parameter profile
5) Multi-function	17) Latch
6) Alarms	18) Batch counter
7) PID1, 2	19) Interval timer
8) Summer 1, 2	20) Filters
9) Run mode ramps	21) Comparators
10) Diameter calc	22) C/O Switches
11) Taper tension	23) All terminal outputs

3.1.3 Logic levels

Logic inputs will recognise the value **zero**, (any units), as a logic low. All other numbers, including negative numbers, will be recognised as a logic high.

3.1.4 Activating blocks

In order to activate a block it is necessary to configure its GOTO window to a PIN other than 400)Block disconnect. In the CONFIGURATION menu first enter the ENABLE GOTO, GETFROM window and set it to ENABLED. Then staying in the CONFIGURATION menu proceed to BLOCK OP CONFIG to find the appropriate GOTO. (Note, The GOTO windows for Multi function 1- 8, Comparator 1-4 and C/O switch 1-4 are contained within each block menu for convenience). After completing the connection return to the ENABLE GOTO, GETFROM window and set it to DISABLED.

3.1.5 CONFLICT HELP MENU

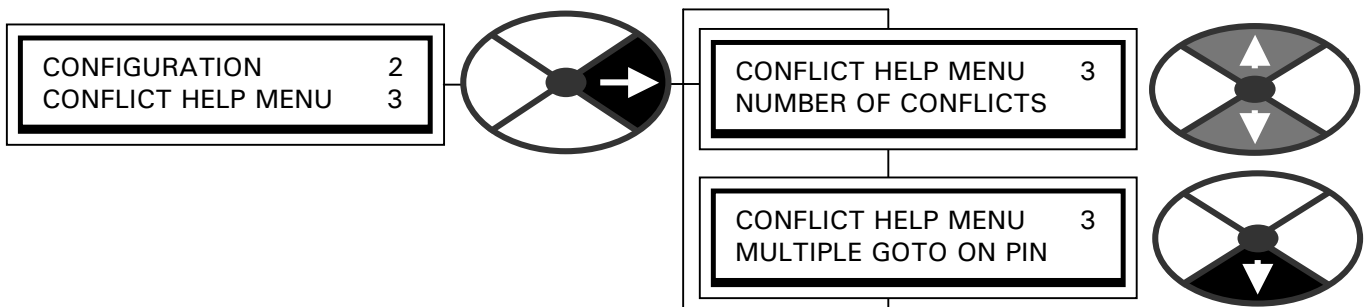

If there has been an accidental connection of more than one GOTO to any PIN, then when the ENABLE GOTO, GETFROM is set to DISABLED, (this is done at the end of a configuration session), the automatic conflict checker will give the alarm message GOTO CONFLICT. This menu is provided to assist the user in locating the PIN with the GOTO conflict.

Proceed to the CONFLICT HELP MENU in the CONFIGURATION menu (see product manual) to find the number of conflicting GOTO connections, and the target PIN that causes the conflict. One of the GOTO connections must be removed to avoid the conflict.

This process is repeated until there are no conflicts.

Note that this tool is extremely helpful. Without it there is the possibility that user GOTO configuration errors would cause multiple values to alternately appear at the conflict PIN resulting in unusual system behaviour.

APPLICATION BLOCKS menu
 The application blocks can be used to create complex control applications.

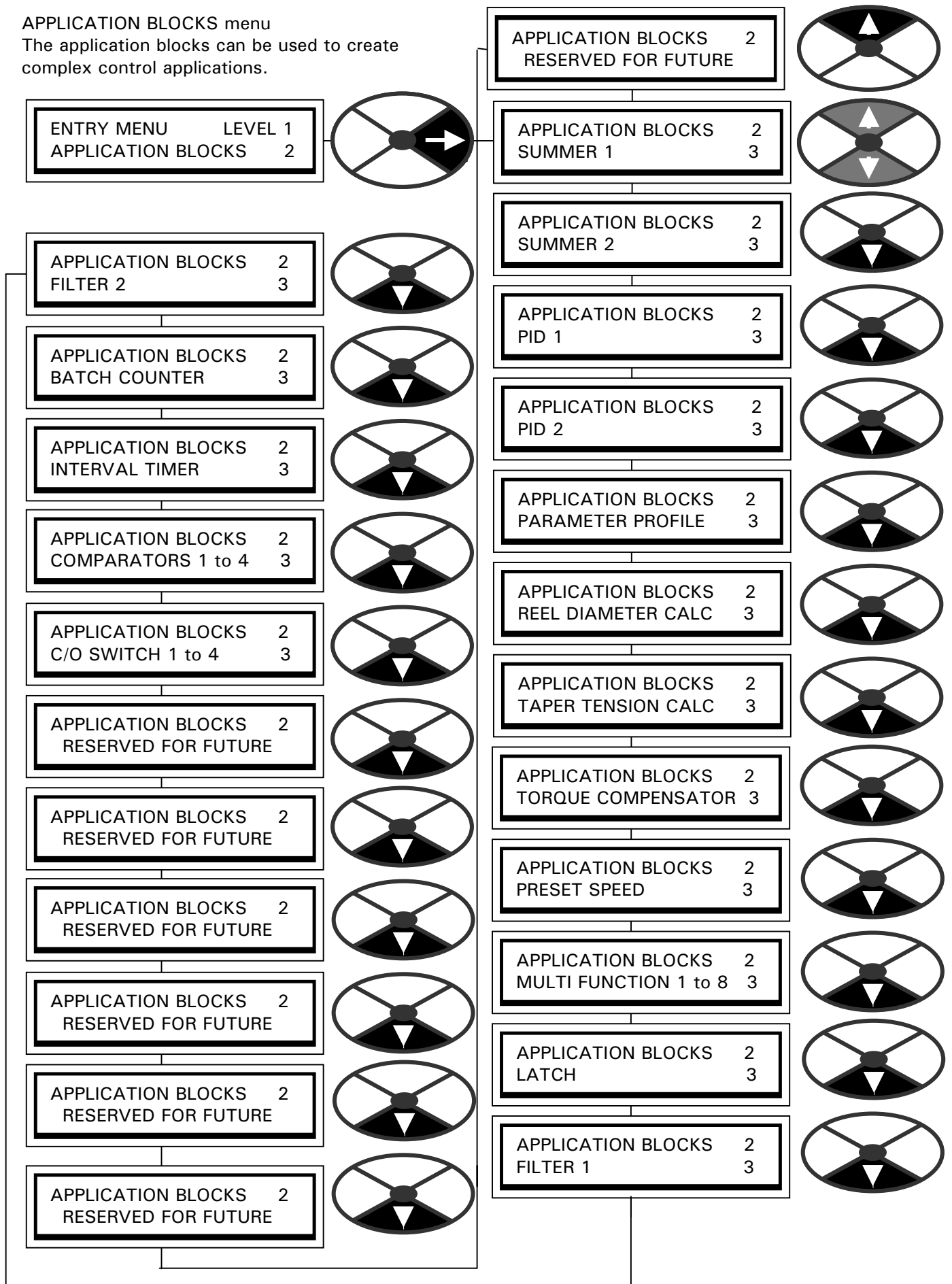

3.2 APPLICATION BLOCKS / SUMMER 1, 2

PIN number range 401 to 427.

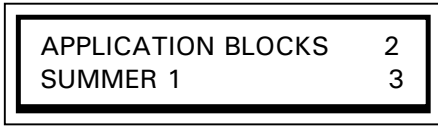

Summer 1 and 2 are identical apart from the PIN numbers. The PIN numbers for both summers are in the section headings.

There are 2 hidden PINs in each block for CH2 and CH1 subtotal outputs.

SUMMER1: Pins 691 Ch2 and 692 Ch1.
 SUMMER2: Pins 693 Ch2 and 694 Ch1

This menu allows programming of a general purpose signal summing and scaling block.

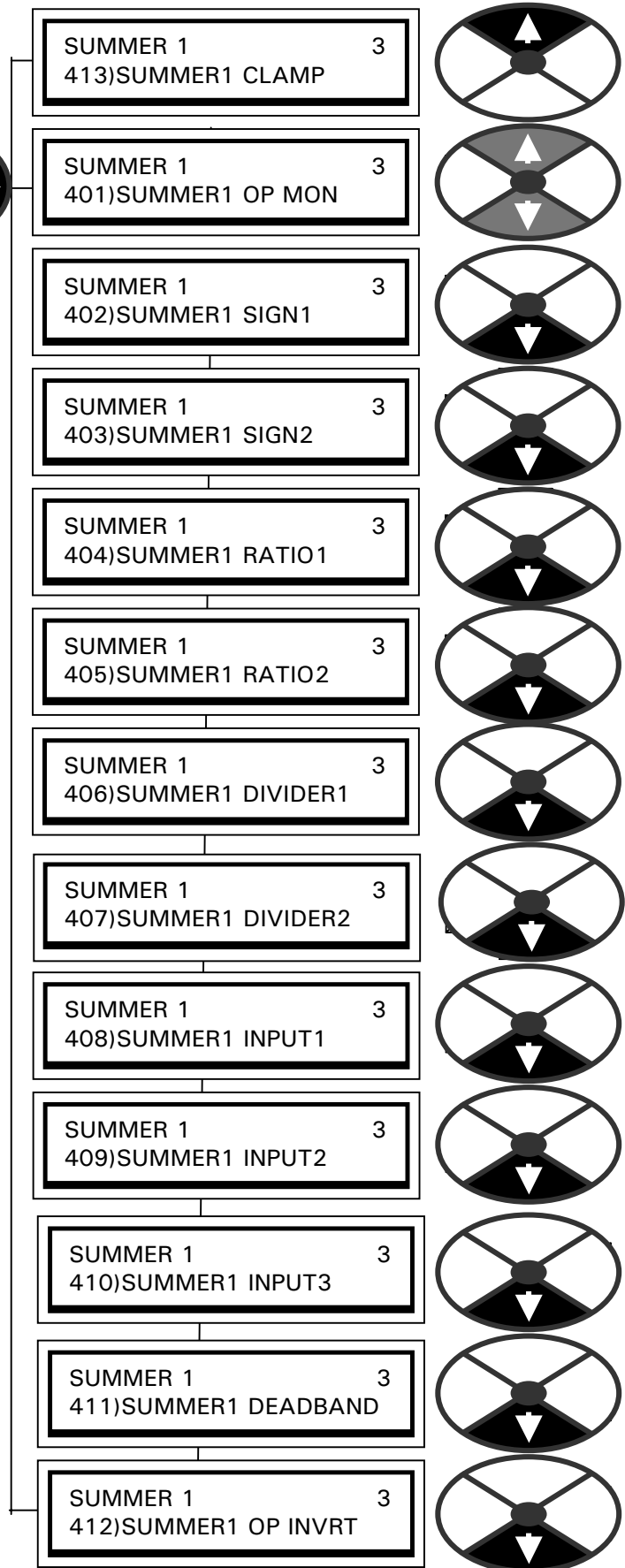

3.2.1 SUMMER 1, 2 / Block diagram

There are 2 identical independant SUMMER blocks

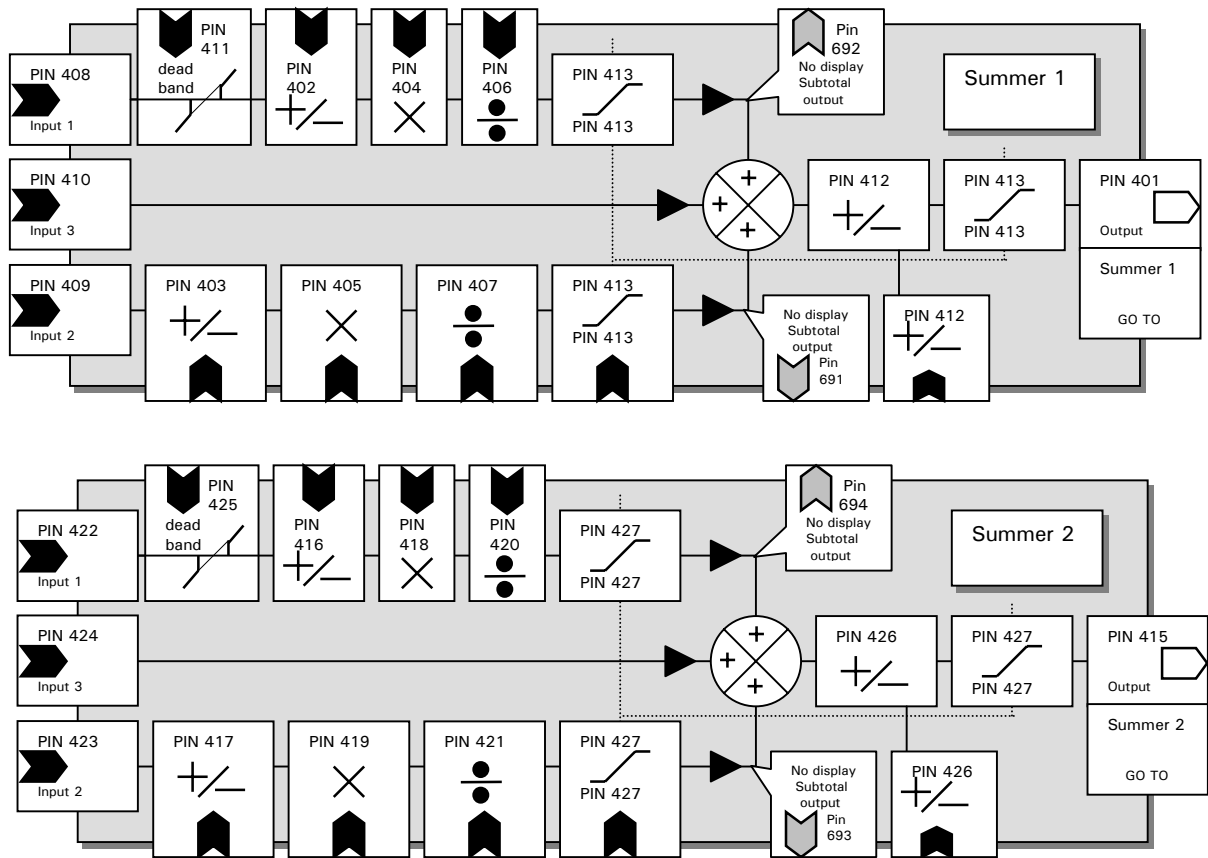

3.2.2 SUMMER 1, 2 / Total output monitor PIN 401 / 415

SUMMER 1

401)SUMMER1 OP MON

3

401)SUMMER1 OP MON

0.00%

Monitors the final total output value of the summer block.

PARAMETER	RANGE	DEFAULT	PIN
SUMMER1 OP MON	+/-200.00%	0.00%	401

3.2.3 SUMMER 1, 2 / Sign 1 PIN 402 / 416

SUMMER 1

402)SUMMER1 SIGN1

3

402)SUMMER1 SIGN1

NON-INVERT

Used to invert the signal arriving at input 1.

PARAMETER	RANGE	DEFAULT	PIN
SUMMER1 SIGN1	INVERT or NON-INVERT	NON-INVERT	402

3.2.4 SUMMER 1, 2 / Sign 2 PIN 403 / 417

SUMMER 1 3
403)SUMMER1 SIGN2

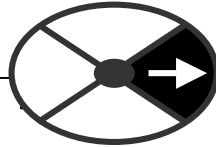

403)SUMMER1 SIGN2
NON-INVERT

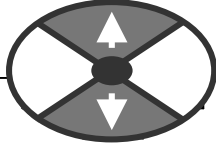

Used to invert the signal arriving at input 2.

PARAMETER	RANGE	DEFAULT	PIN
SUMMER1 SIGN 2	INVERT or NON-INVERT	NON-INVERT	403

3.2.5 SUMMER 1, 2 / Ratio 1 PIN 404 / 418

SUMMER 1 3
404)SUMMER1 RATIO1

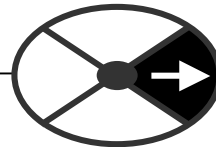

404)SUMMER1 RATIO1
1.0000

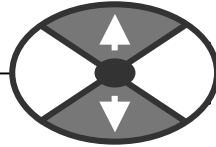

Sets the ratio value for the signal arriving at input 1.

PARAMETER	RANGE	DEFAULT	PIN
SUMMER1 RATIO1	+/-3.0000	1.0000	404

3.2.6 SUMMER 1, 2 / Ratio 2 PIN 405 / 419

SUMMER 1 3
405)SUMMER1 RATIO2

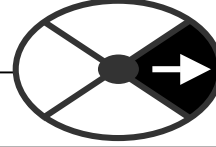

405)SUMMER1 RATIO2
1.0000

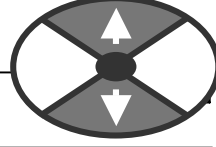

Sets the ratio value for the signal arriving at input 2.

PARAMETER	RANGE	DEFAULT	PIN
SUMMER1 RATIO2	+/-3.0000	1.0000	405

3.2.7 SUMMER 1, 2 / Divider 1 PIN 406 / 420

SUMMER 1 3
406)SUMMER1 DIVIDER1

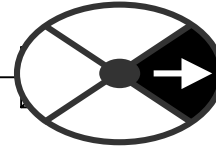

406)SUMMER1 DIVIDER1
1.0000

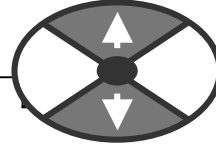

Sets divisor for signal arriving at IP1. A zero gives zero output

PARAMETER	RANGE	DEFAULT	PIN
SUMMER1 DIVIDER1	+/-3.0000	1.0000	406

3.2.8 SUMMER 1, 2 / Divider 2 PIN 407 / 421

SUMMER 1 3
407)SUMMER1 DIVIDER2

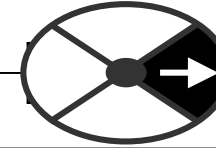

407)SUMMER1 DIVIDER2
1.0000

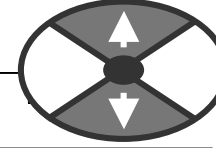

Sets divisor for signal arriving at IP2. A zero gives zero output

PARAMETER	RANGE	DEFAULT	PIN
SUMMER1 DIVIDER2	+/-3.0000	1.0000	407

3.2.9 SUMMER 1, 2 / Input 1 PIN 408 / 422

SUMMER 1 3
408)SUMMER1 INPUT1

408)SUMMER1 INPUT1
0.00%

Sets value for input 1.

PARAMETER	RANGE	DEFAULT	PIN
SUMMER1 INPUT1	+/-300.00%	0.00%	408

3.2.10 SUMMER 1, 2 / Input 2 PIN 409 / 423

SUMMER 1 3
409)SUMMER1 INPUT2

409)SUMMER1 INPUT2
0.00%

Sets value for input 2.

PARAMETER	RANGE	DEFAULT	PIN
SUMMER1 INPUT2	+/-300.00%	0.00%	409

3.2.11 SUMMER 1, 2 / Input 3 PIN 410 / 424

SUMMER 1 3
410)SUMMER1 INPUT3

410)SUMMER1 INPUT3
0.00%

Sets value for input 3.

PARAMETER	RANGE	DEFAULT	PIN
SUMMER1 INPUT3	+/-300.00%	0.00%	410

3.2.12 SUMMER 1, 2 / Deadband PIN 411 / 425

SUMMER 1 3
411)SUMMER1 DEADBAND

411)SUMMER1 DEADBAND
0.00%

Sets +/- % deadband width centred on 0.00% for input 1.

PARAMETER	RANGE	DEFAULT	PIN
SUMMER1 DEADBAND	0.00 to 100.00%	0.00%	411

3.2.13 SUMMER 1, 2 / Output sign inverter PIN 412 / 426

SUMMER 1 3
412)SUMMER1 OP INVRT

412)SUMMER1 OP INVRT
NON-INVERT

Used to invert the output signal from the summing block.

PARAMETER	RANGE	DEFAULT	PIN
SUMMER1 OP INVRT	INVERT / NON-INVERT	NON-INVERT	412

3.2.14 SUMMER 1, 2 / Symmetrical clamp PIN 413 / 427

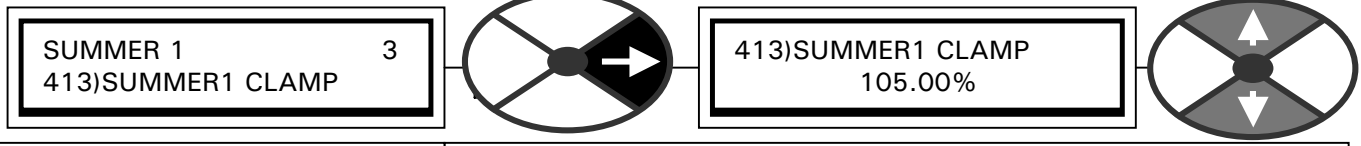

Sets the value of a symmetrical clamp for inputs 1, 2 and output	PARAMETER	RANGE	DEFAULT	PIN
	SUMMER1 CLAMP	0.00 to 200.00%	105.00%	413

The subtotal values after clamping for SUMMER1 are available on hidden PIN 692 (CH1) and 691 (CH2)
 The subtotal values after clamping for SUMMER2 are available on hidden PIN 694 (CH1) and 693 (CH2)

3.3 APPLICATION BLOCKS / PID 1, 2.

There are 2 identical PID blocks.
Pins 429 to 474

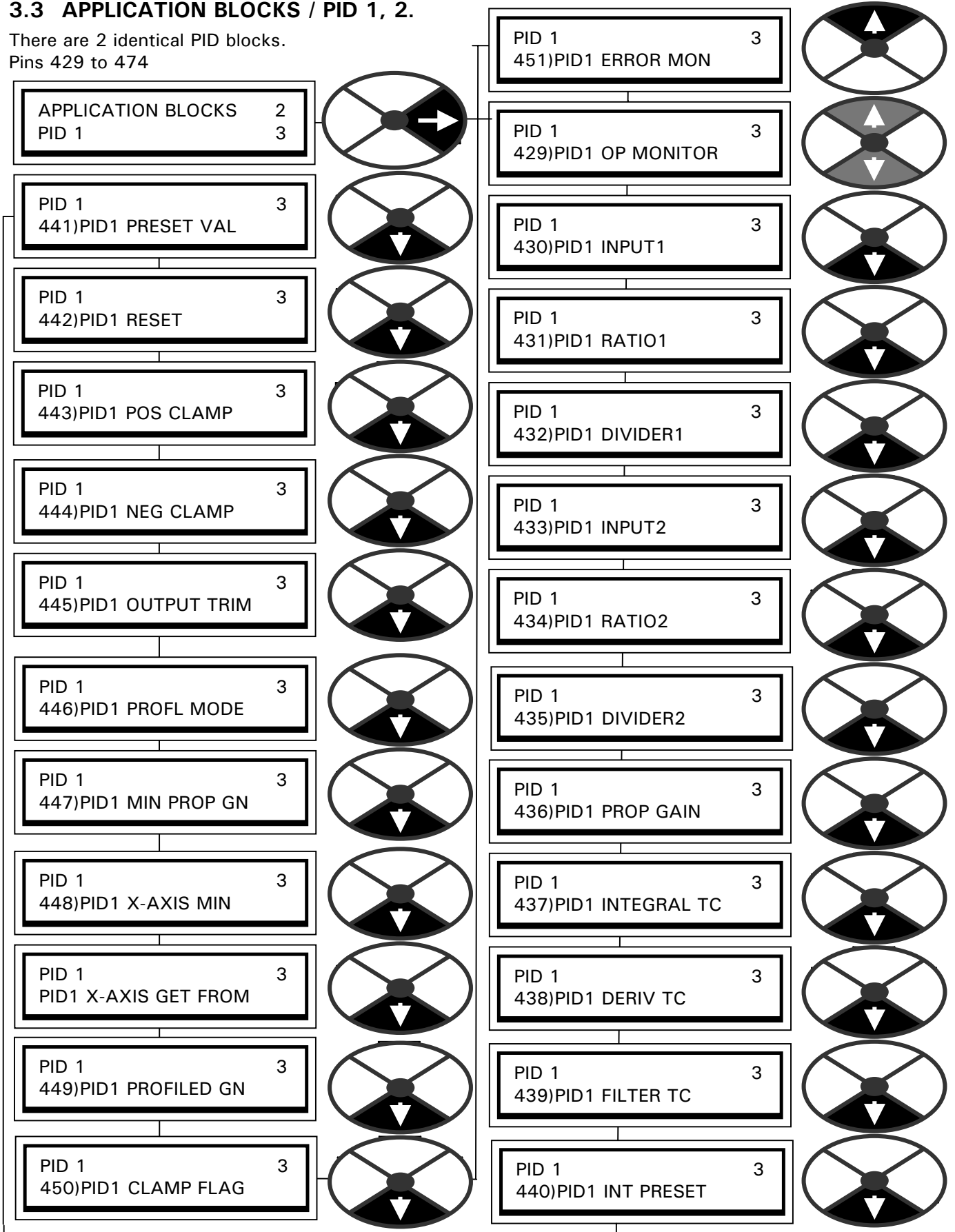

This block performs the function of a classical PID to allow insertion of an exterior control loop around the basic drive loops. Typical uses are, Dancer arm, loadcell tension, centre driven winding.

Features:-

Independent adjustment and selection of P, I, D.

Scaling of feedback and reference inputs.

Adjustable filter.

Preset mode on integral term.

Output scaler with independent +/-limit clamps.

Built in gain profiling option.

3.3.1 PID 1, 2 / Block diagram

2 identical independant PID blocks

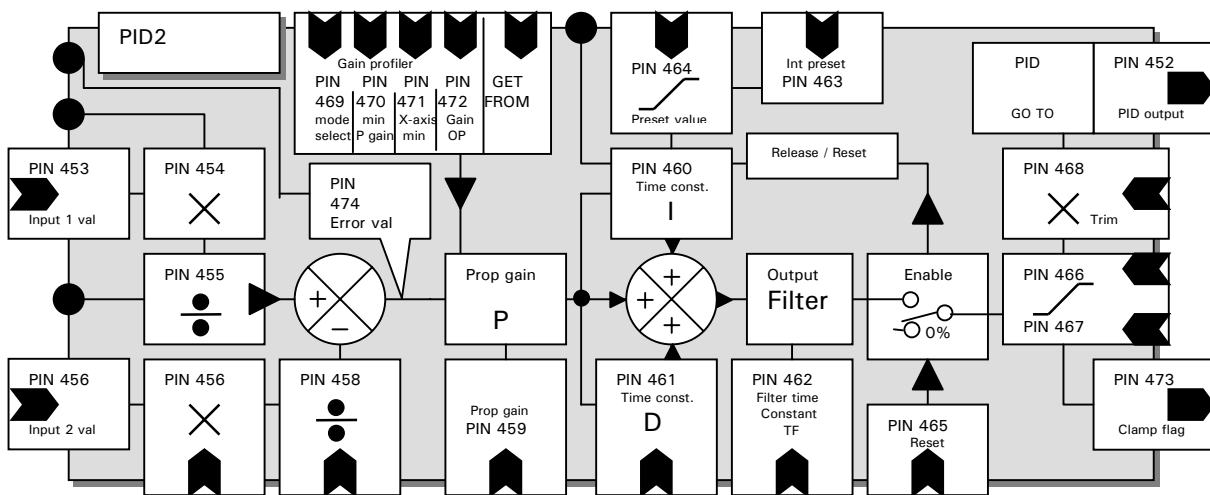
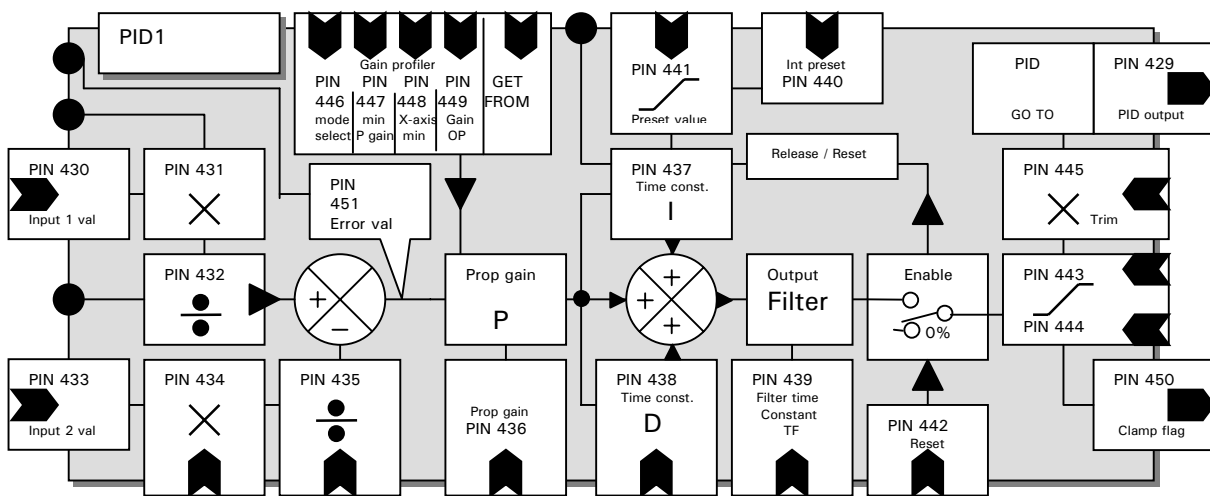

3.3.2 PID 1, 2 / PID output monitor PIN 429 / 452

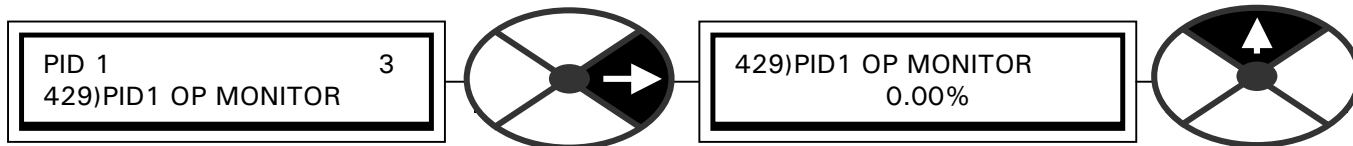

This is the final output of the PID1 block.

PARAMETER	RANGE	PIN
PID1 OP MONITOR	+/-300.00%	429

This window has a branch hopping facility to 3.3.25 PID 1, 2 / PID error value monitor PIN 451 / 474

3.3.3 PID 1, 2 / PID IP1 value PIN 430 / 453

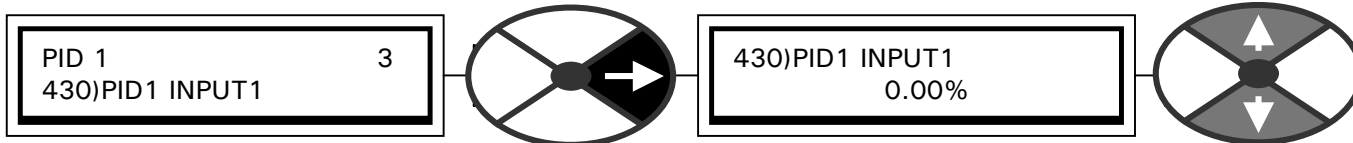

Sets value for PID input 1. This is normally the PID reference.

PARAMETER	RANGE	DEFAULT	PIN
PID1 INPUT1	+/-300.00%	0.00%	430

3.3.4 PID 1, 2 / PID IP1 ratio PIN 431 / 454

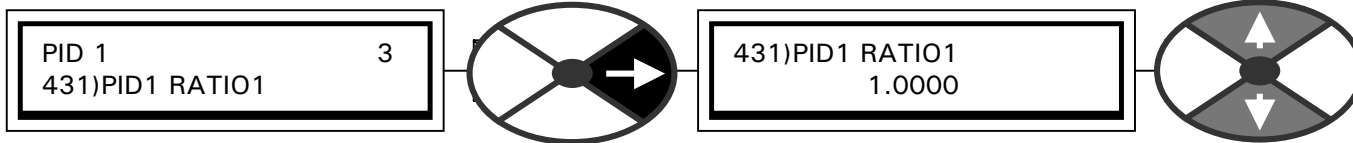

Sets the scaling factor for the PID input 1 value.

PARAMETER	RANGE	DEFAULT	PIN
PID1 RATIO1	+/-3.0000	1.0000	431

3.3.5 PID 1, 2 / PID IP1 divider PIN 432 / 455

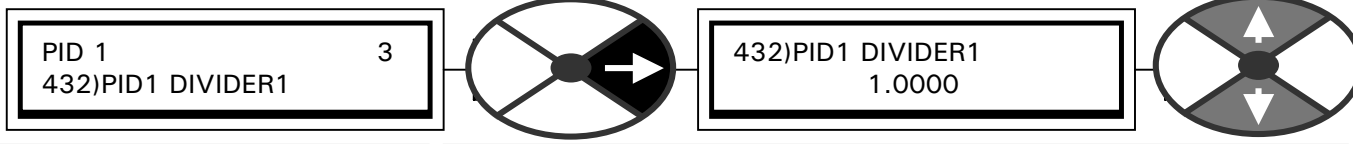

Sets divisor for IP1 signal channel. Zero gives zero output

PARAMETER	RANGE	DEFAULT	PIN
PID1 DIVIDER1	+/-3.0000	1.0000	432

3.3.6 PID 1, 2 / PID IP2 value PIN 433 / 456

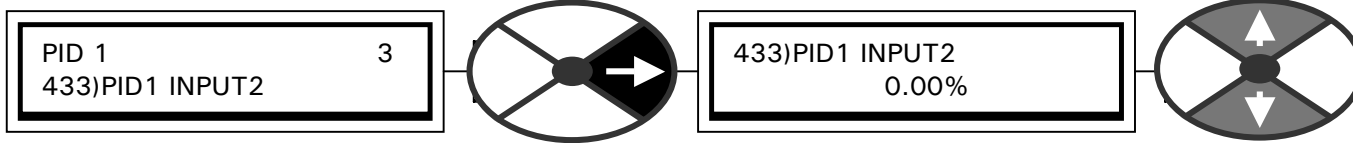

Sets value for PID input 2. This is normally the PID reference.

PARAMETER	RANGE	DEFAULT	PIN
PID1 INPUT2	+/-300.00%	0.00%	433

3.3.7 PID 1, 2 / PID IP2 ratio PIN 434 / 457

PID 1 3
 434)PID1 RATIO2

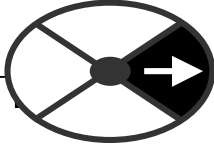

434)PID1 RATIO2
 1.0000

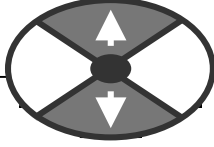

Sets the scaling factor for the PID input 2 value.

PARAMETER	RANGE	DEFAULT	PIN
PID1 RATIO2	+/-3.0000	1.0000	434

3.3.8 PID 1, 2 / PID IP2 divider PIN 435 / 458

PID 1 3
 435)PID1 DIVIDER2

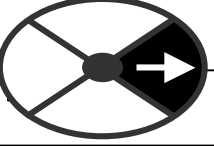

435)PID1 DIVIDER2
 1.0000

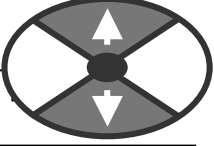

Sets divisor for IP2 signal channel. Zero gives zero output

PARAMETER	RANGE	DEFAULT	PIN
PID1 DIVIDER2	+/-3.0000	1.0000	435

3.3.9 PID 1, 2 / PID proportional gain PIN 436 / 459

PID 1 3
 436)PID1 PROP GAIN

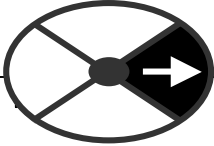

436)PID1 PROP GAIN
 1.0

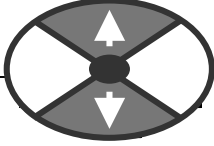

Sets the PID gain independently of the I and D time constants.

PARAMETER	RANGE	DEFAULT	PIN
PID1 PROP GAIN	0.0 to 100.0	1.0	436

Proportional output = gain X (1 + DiffT/IntT) X error%. A higher gain usually provides a faster response. Normally the DiffT is much smaller than IntT, hence the equation then approximates to:-
 Prop output = gain X error%.

E. g. A gain of 10 and a step change in the error of 10% will result in a step change at the output of 100%.
 Note. The gain may be profiled using the PARAMETER PROFILE section within this menu.

3.3.10 PID 1, 2 / PID integrator time constant PIN 437 / 460

PID 1 3
 437)PID1 INTEGRAL TC

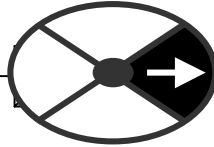

437)PID1 INTEGRAL TC
 5.00 SECS

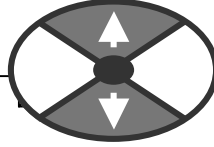

Sets the PID integrator time constant.

PARAMETER	RANGE	DEFAULT	PIN
PID1 INTEGRAL TC	0.01 to 100.00 seconds	5.00 secs	437

Note. Processes that take a long time to react will usually require a longer integrator time constant. When the PID output reaches the clamp limits the integrator is held at the prevailing condition. The clamp levels are also separately applied to the internal integrator term result. See 3.3.16 and 3.3.17 .PID 1, 2 / PID negative clamp level PIN 444 / 467

3.3.11 PID 1, 2 / PID derivative time constant PIN 438 / 461

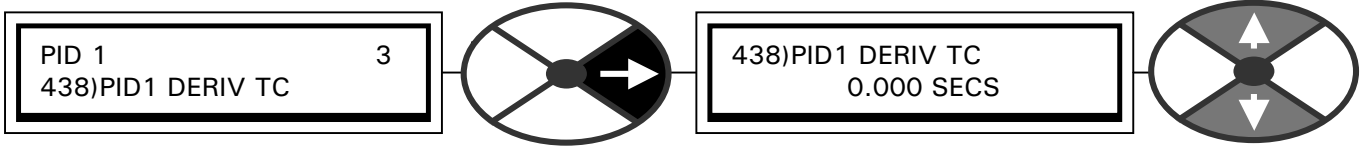

Sets the PID derivative time constant.

PARAMETER	RANGE	DEFAULT	PIN
PID1 DERIV TC	0.000 to 10.000 seconds	0.000 secs	438

If the derivative time constant is set to 0.000, then the D term is effectively removed from the block. Loops that require a rapid response but suffer from overshoot normally benefit from a smaller derivative time constant.

3.3.12 PID 1, 2 / PID derivative filter time constant PIN 439 / 462

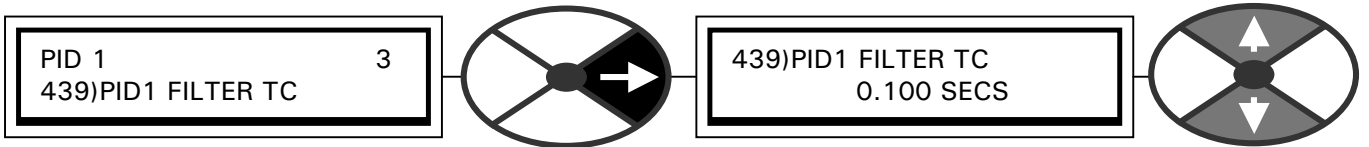

Sets the time constant of the PID output filter.

PARAMETER	RANGE	DEFAULT	PIN
PID1 FILTER TC	0.000 to 10.000 seconds	0.100 secs	439

The derivative of a noisy error signal can lead to unwanted output excursions. This filter time constant is typically set at DERIV TC/5 (See above). A time constant of 0.000 will turn the filter off. The filter is applied to the sum of the P, I and D terms.

3.3.13 PID 1, 2 / PID integrator preset PIN 440 / 463

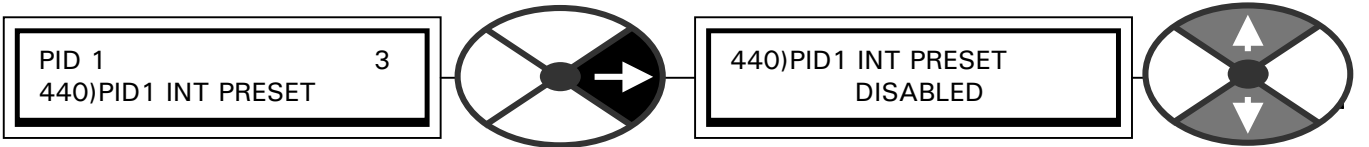

Enables the integrator to be preset to the value in PIN 441.

PARAMETER	RANGE	DEFAULT	PIN
PID1 INT PRESET	ENABLED or DISABLED	DISABLED	440

Note. The PID INT PRESET function operates independantly from the PID RESET function. If the integrator preset is permanently enabled then the I term is effectively removed from the block.

3.3.14 PID 1, 2 / PID integrator preset value PIN 441 / 464

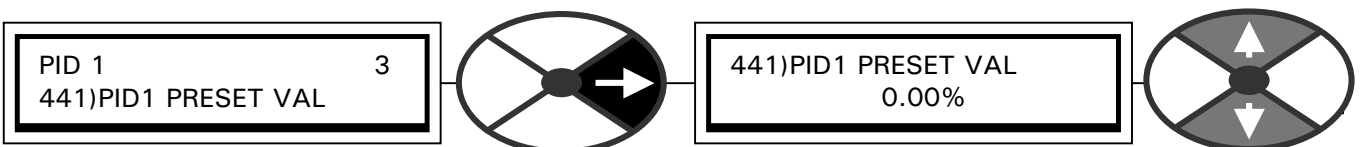

This integrator preset value is enabled by PID1 INT PRESET.

PARAMETER	RANGE	DEFAULT	PIN
PID1 PRESET VAL	+/-300.00%	0.00%	441

Note. The preset function is overridden by the PID RESET function.

3.3.15 PID 1, 2 / PID reset PIN 442 / 465

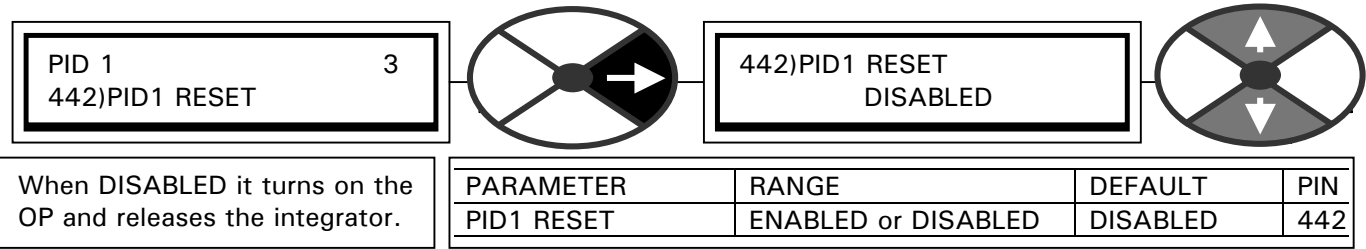

Note. When the reset is ENABLED the output stage and the integrator are set to 0.00%.
 Note. The PID RESET operates independantly from and has priority over the integrator preset function.

3.3.16 PID 1, 2 / PID positive clamp level PIN 443 / 466

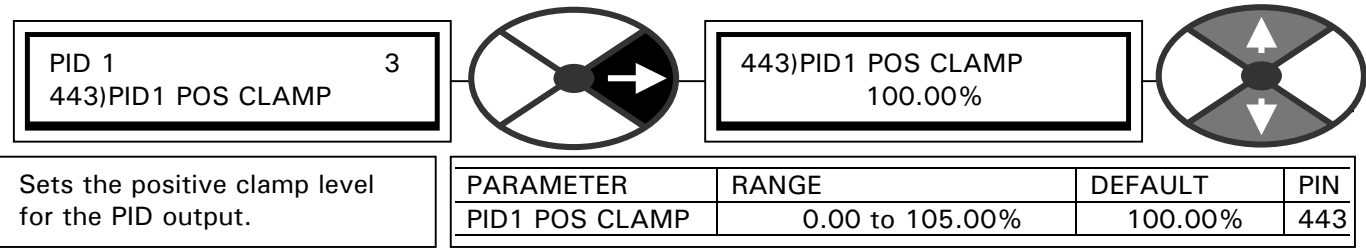

Note. When the output is being clamped at this level, the integrator is held at its prevailing value

3.3.17 PID 1, 2 / PID negative clamp level PIN 444 / 467

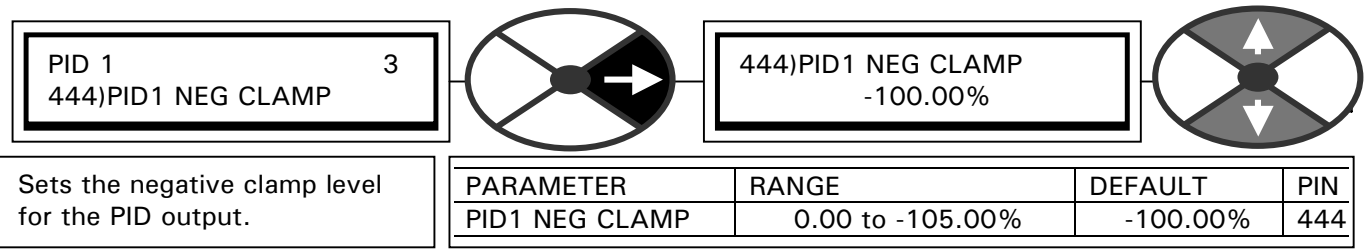

Note. When the output is being clamped at this level, the integrator is held at its prevailing value

3.3.18 PID 1, 2 / PID output % trim PIN 445 / 468

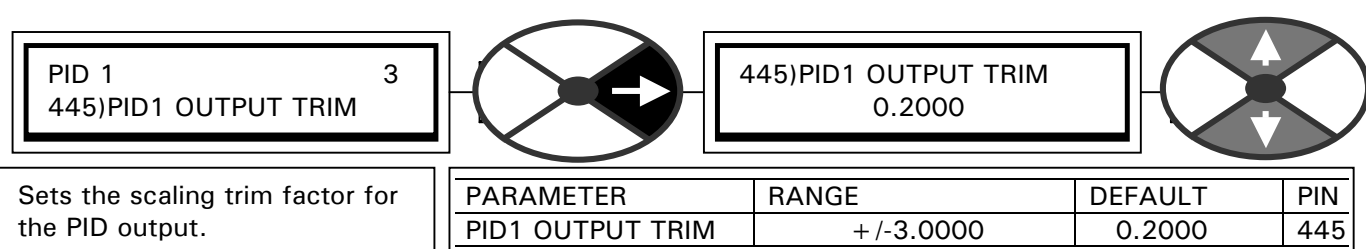

The output of the PID may be inverted by selecting a negative trim factor.

3.3.19 PID 1, 2 / PID profile mode select PIN 446 / 469

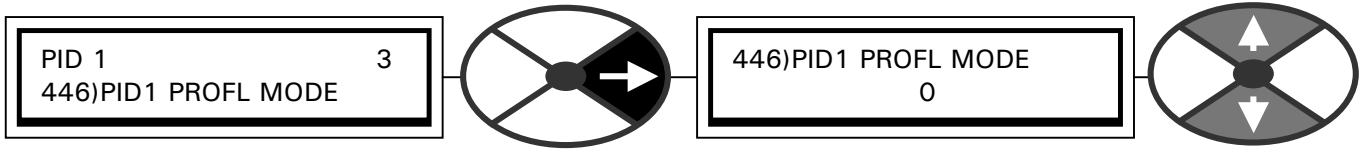

Allows selection of gain profile curve shape

PARAMETER	RANGE	DEFAULT	PIN
PID1 PROFL MODE	1 of 5 modes	0	446

Mode	Law of profile curve
0	Yaxis output = Yaxis MAX
1	Yaxis output = Linear change between MIN and MAX
2	Yaxis output = Square law change between MIN and MAX
3	Yaxis output = Cubic law change between MIN and MAX
4	Yaxis output = 4 th power law change between MIN and MAX

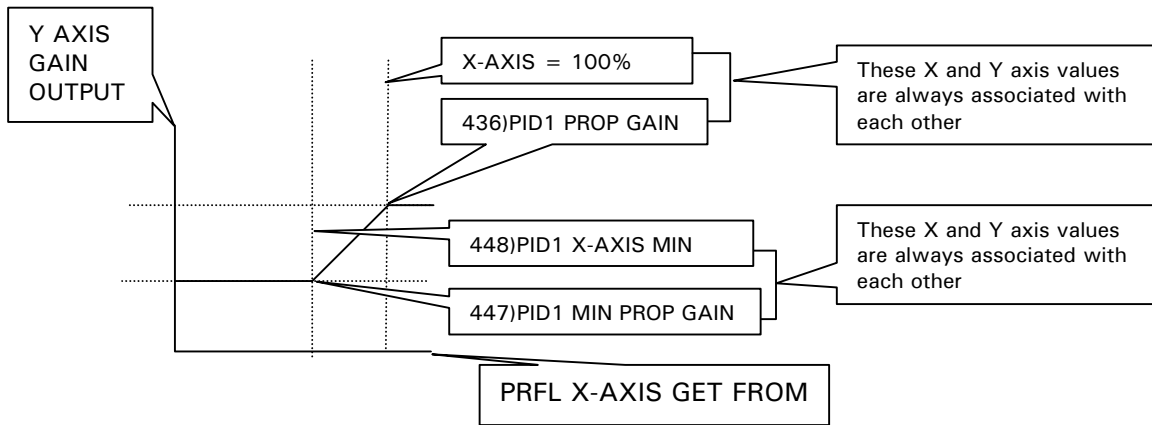

3.3.20 PID 1, 2 / PID minimum proportional gain PIN 447 / 470

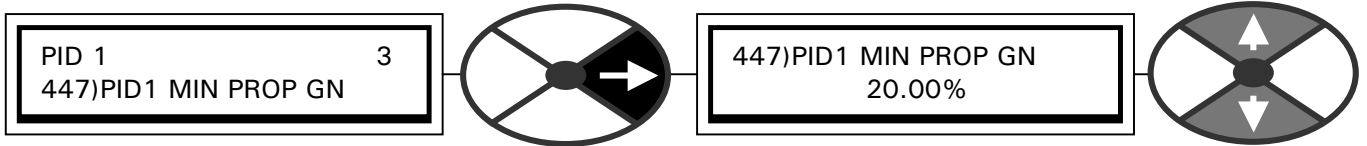

Sets the minimum value for the PID parameter profile output.

PARAMETER	RANGE	DEFAULT	PIN
PID1 MIN PROP GN	0.00 to 100.00%	20.00%	447

3.3.21 PID 1, 2 / PID Profile X axis minimum PIN 448 / 471

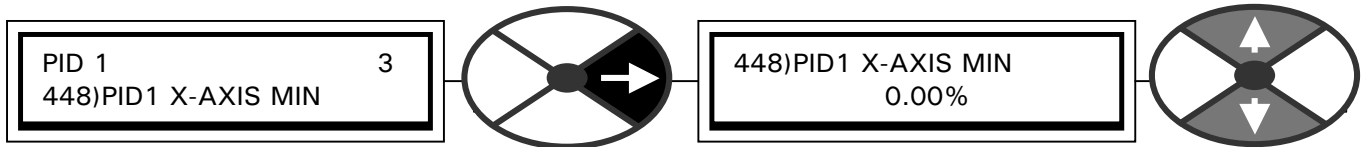

Sets the minimum value for the PID parameter profile X-AXIS.

PARAMETER	RANGE	DEFAULT	PIN
PID1 X-AXIS MIN	0.00 to 100.00%	0.00%	448

3.3.22 PID 1, 2 / PID Profile X axis GET FROM

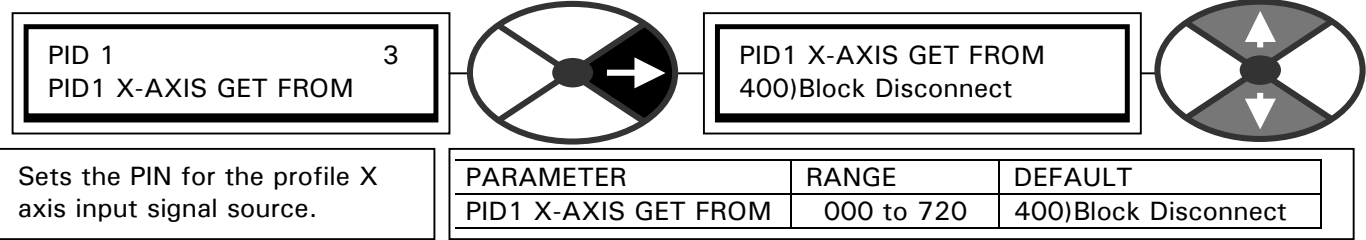

Note This GET FROM input has a built in rectifier and hence will accept bi-polar or unipolar inputs.

3.3.23 PID 1, 2 / PID Profiled prop gain output monitor PIN 449 / 472

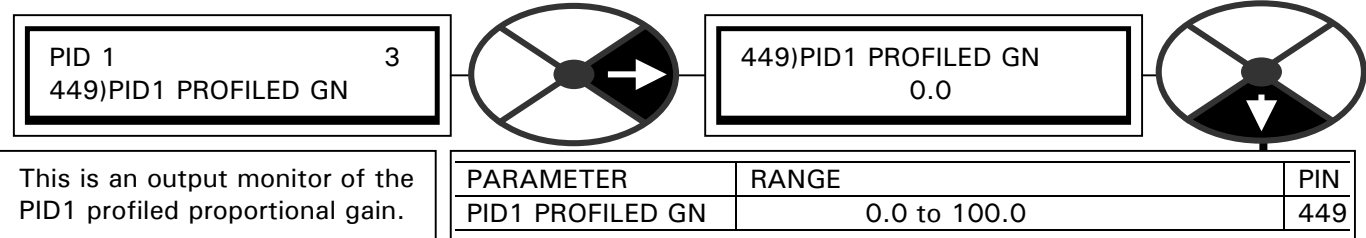

This window has a branch hopping facility.

3.3.24 PID 1, 2 / PID clamp flag monitor PIN 450 / 473

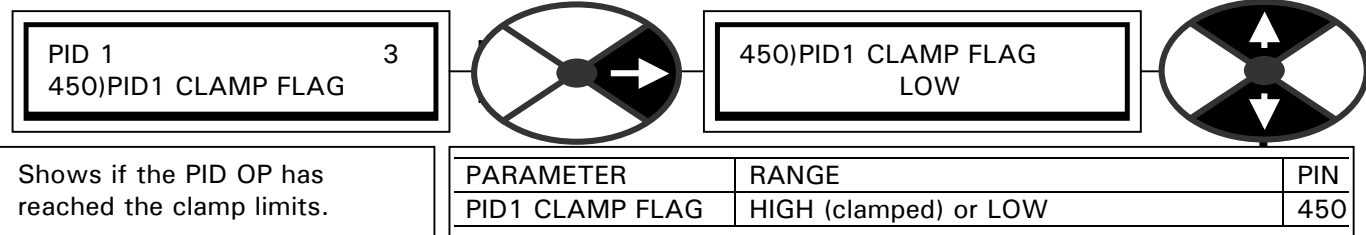

See 3.3.16 and 3.3.17 PID 1, 2 / PID negative clamp level PIN 444 / 467.

This window has a branch hopping facility.

3.3.25 PID 1, 2 / PID error value monitor PIN 451 / 474

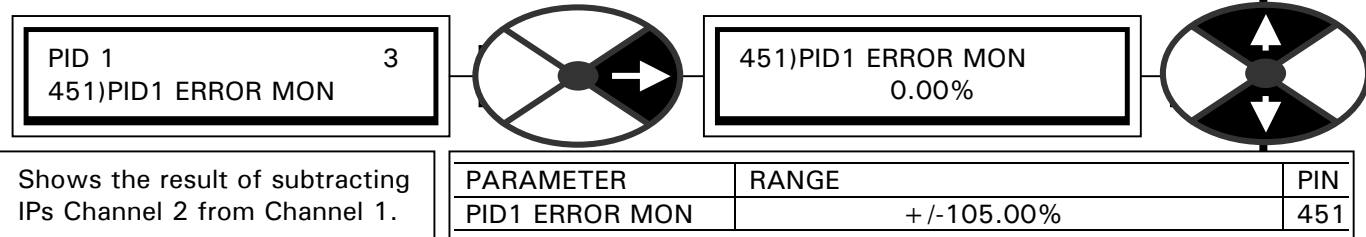

Note. This error signal is internally clamped at +/-105.00%.

This window has a branch hopping facility to 3.3.2 PID 1, 2 / PID output monitor PIN 429 / 452.

3.4 APPLICATION BLOCKS / PARAMETER PROFILER

PINs used 475 to 481

APPLICATION BLOCKS	2
PARAMETER PROFILER	3

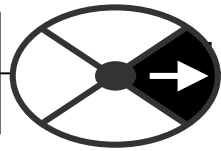

3.4.1 PARAMETER PROFILER / Block diagram

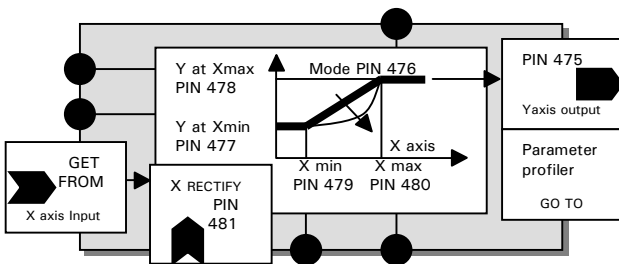

This block is used when it is desirable to modulate one parameter according to the magnitude of another. A typical example is changing the gain of a block as the error increases.

The block symbol shows the profiler working in the positive quadrant by using a rectified version of the input signal to indicate the position on the profile X axis. The related Y axis amplitude is then sent to the block output. Both axes are able to impose maximum and minimum levels to the profile translation. The profile curve is able to adopt several different modes.

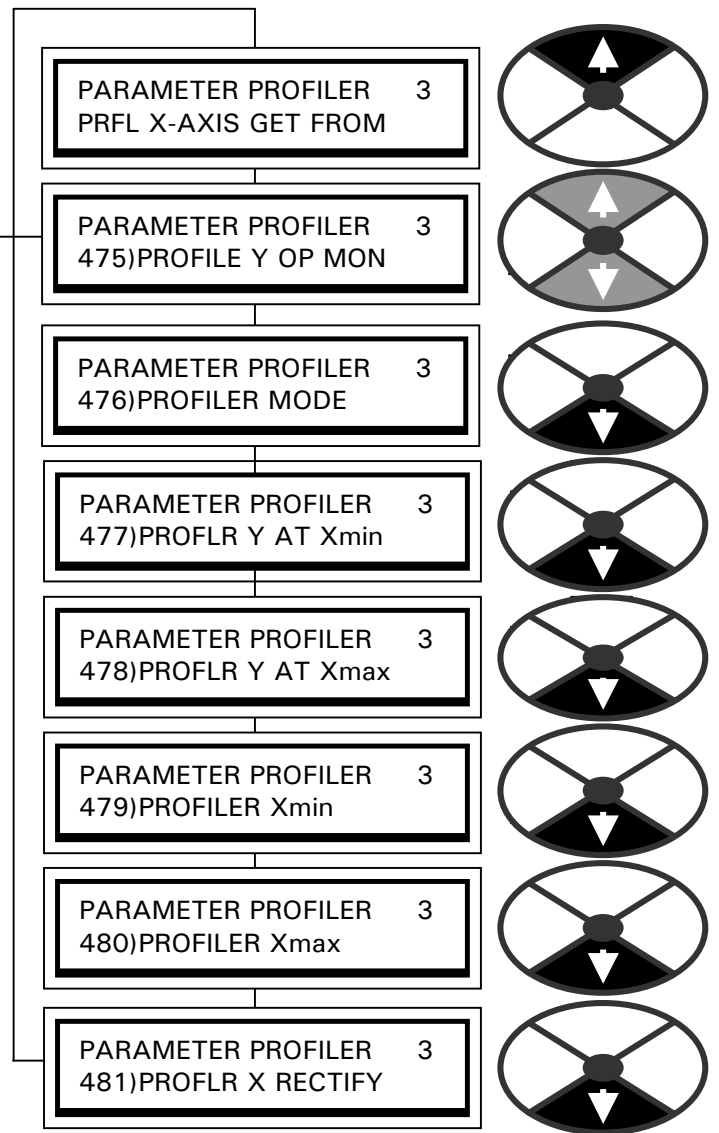

It is possible to use the block in up to 4 quadrants for specialist applications.

The input is connected by using the PRFL X-AXIS GET FROM window in this menu.

3.4.1.1 Profile for Y increasing with X

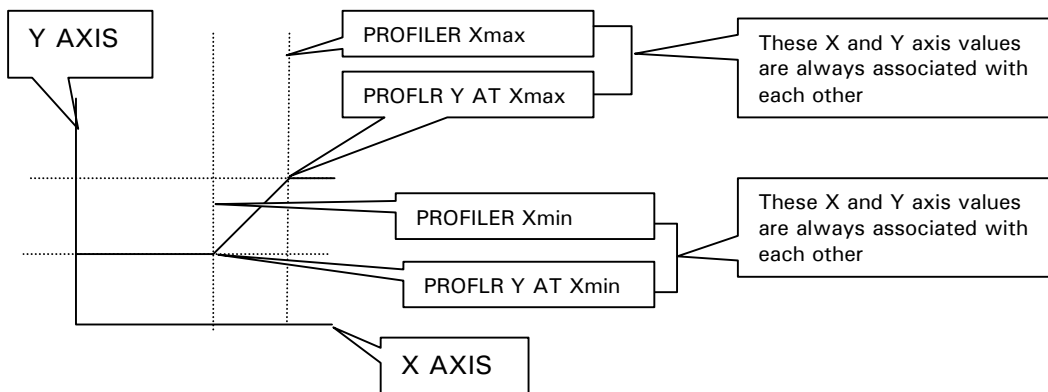

The graph shows the positive quadrant only.

It is useful to consider each pair of min values as a coordinate, and each pair of max values as a coordinate.

3.4.1.2 Profile for Y decreasing with X

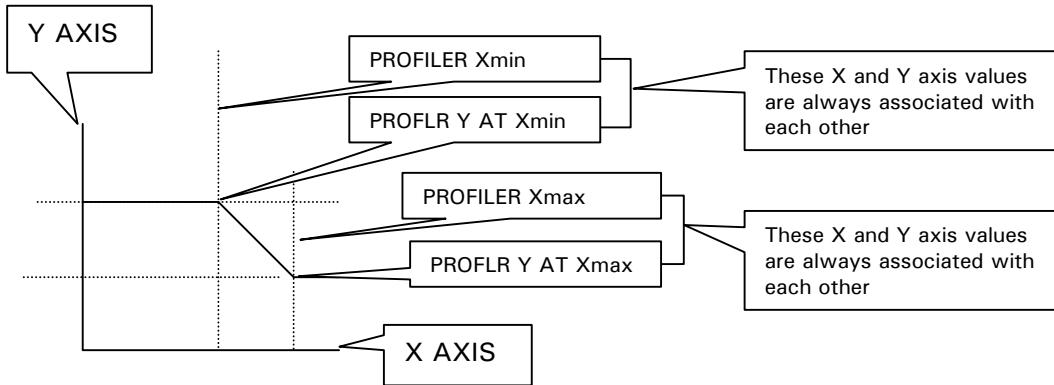

The graph shows the positive quadrant only. It is useful to consider each pair of min values as a coordinate, and each pair of max values as a coordinate.

3.4.1.3 Examples of general profiles

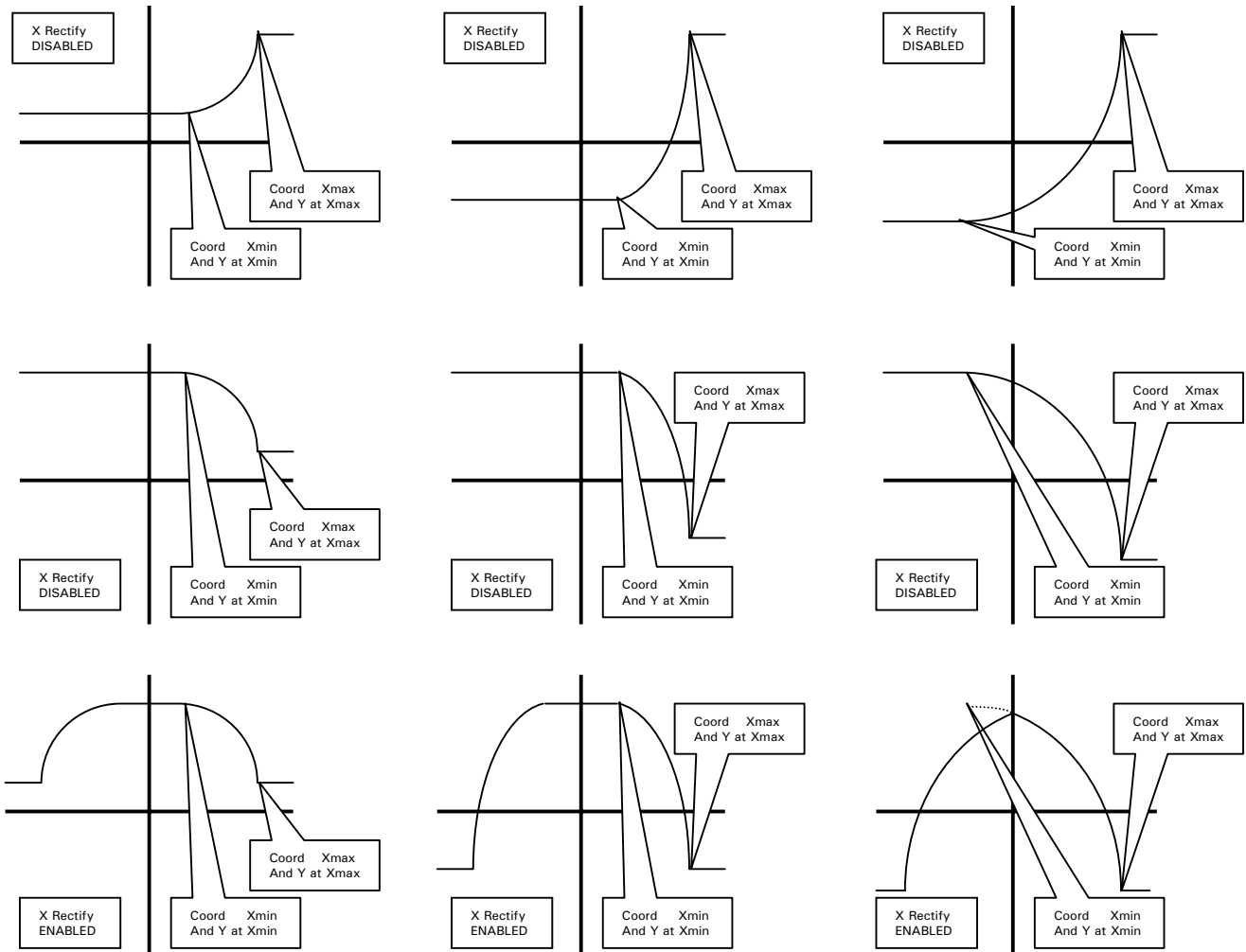

- 1) The above graphs show some of the possible profiles.
- 2) When using 2nd, 3rd or 4th order modes the curve always approaches the Xmin coordinate asymptotically.
- 3) If the value for Xmin is greater or equal to Xmax, then Y is constant and equal to PROFLR Y AT Xmax.
- 4) If the PROFILER MODE is set to 0 then Y is constant and equal to PROFLR Y AT Xmax.

3.4.2 PARAMETER PROFILER / Profile Y output monitor PIN 475

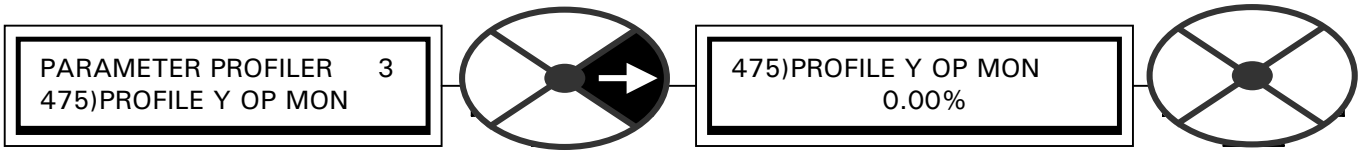

This is the final output monitor of the parameter profiler block.

PARAMETER	RANGE	DEFAULT	PIN
PROFILE Y OP MON	+/-300.00%	0.00%	475

3.4.3 PARAMETER PROFILER / Profiler mode PIN 476

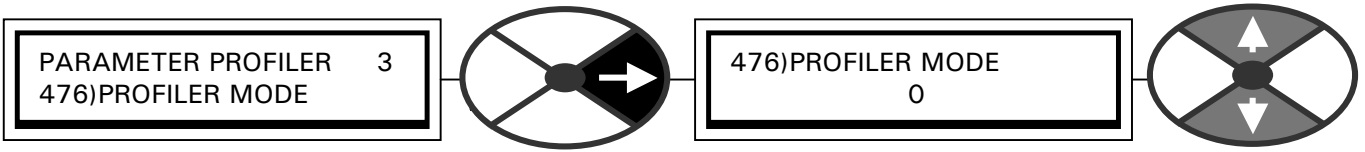

Sets the mode of the profile curve between **min** and **max**.

PARAMETER	RANGE	DEFAULT	PIN
PROFILER MODE	1 of 5 modes	0	476

Mode	Law of profile curve
0	Yaxis output = Y at Xmax
1	Yaxis output = Linear change between min coords and max coords
2	Yaxis output = Square law change between min coords and max coords
3	Yaxis output = Cubic law change between min coords and max coords
4	Yaxis output = 4 th power law change between min coords and max coords

3.4.4 PARAMETER PROFILER / Profile Y at Xmin PIN 477

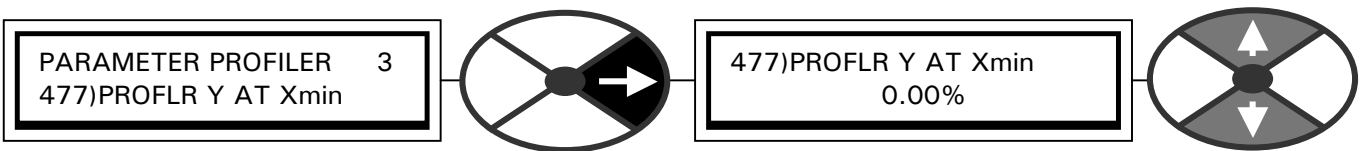

Sets the corresponding value for the Y axis at Xmin.

PARAMETER	RANGE	DEFAULT	PIN
PROFLR Y AT Xmin	+/-300.00%	0.00%	477

3.4.5 PARAMETER PROFILER / Profiler Y at Xmax PIN 478

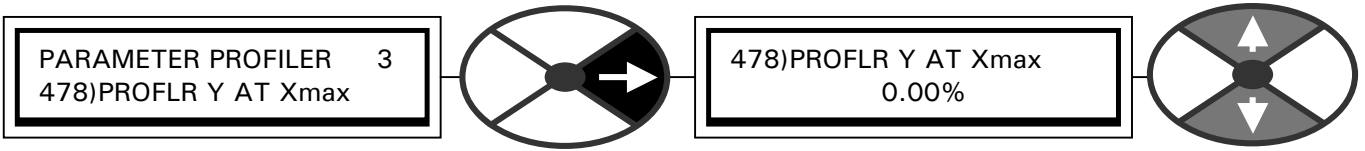

Sets the corresponding value for the Y axis at Xmax.

PARAMETER	RANGE	DEFAULT	PIN
PROFLR Y AT Xmax	+/-300.00%	100.00%	478

3.4.6 PARAMETER PROFILER / Profile X axis minimum PIN 479

PARAMETER PROFILER 3
479)PROFILER Xmin

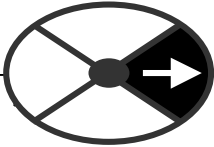

479)PROFILER Xmin
0.00%

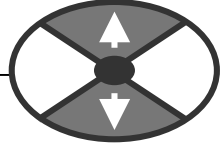

PARAMETER	RANGE	DEFAULT	PIN
PROFILER Xmin	+/-300.00%	0.00%	479

Sets the minimum value for the X axis input.

If the value for Xmin is greater or equal to Xmax, then Y is constant and equal to PROFLR Y AT Xmax.

3.4.7 PARAMETER PROFILER / Profile X axis maximum PIN 480

PARAMETER PROFILER 3
480)PROFILER Xmax

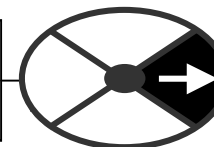

480)PROFILER Xmax
100.00%

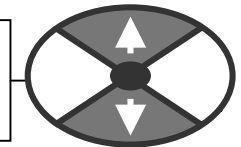

PARAMETER	RANGE	DEFAULT	PIN
PROFL X-AXIS MAX	+/-300.00%	100.00%	480

Sets the maximum value for the X axis input.

If the value for Xmin is greater or equal to Xmax, then Y is constant and equal to PROFLR Y AT Xmax.

3.4.8 PARAMETER PROFILER / Profile X axis rectify PIN 481

PARAMETER PROFILER 3
481)PROFLR X RECTIFY

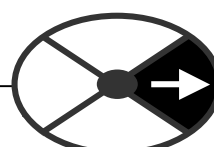

481)PROFLR X RECTIFY
ENABLED

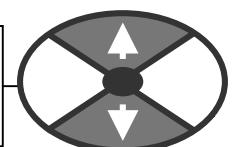

PARAMETER	RANGE	DEFAULT	PIN
PROFLR X RECTIFY	ENABLED OR DISABLED	ENABLED	481

Enables the X axis input to be rectified prior to profiling.

3.4.9 PARAMETER PROFILER / Profile X axis GET FROM

PARAMETER PROFILER 3
PRFL X-AXIS GET FROM

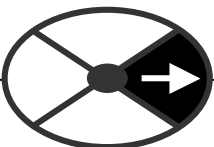

PRFL X-AXIS GET FROM
400)Block Disconnect

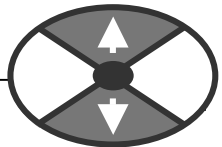

PARAMETER	RANGE	DEFAULT
PRFL X-AXIS GET FROM	000 to 720	400)Block Disconnect

Sets the PIN for the profile X axis input signal source.

3.5 APPLICATION BLOCKS / REEL DIAMETER CALC

PINs used 483 to 493

For a constant web speed the reel shaft slows down as the reel diameter increases. Dividing the web speed by the shaft speed gives the reel diameter.

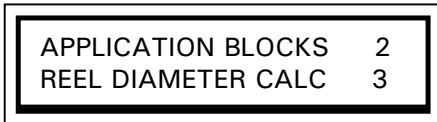

This block performs reel diameter calculation and provides a diameter output for control of web winding tension systems.

The diameter value can be independently preset to any value to allow seamless take up for winding or unwinding applications. There is provision made to suspend diameter calculation if the speed falls below a user preset threshold. The diameter can be programmed to be retained indefinitely during power loss if desired. A filter with adjustable time constant is included which will smooth the calculation output. The block provides a web break alarm flag output with adjustable threshold that compares the input and output of the smoothing filter.

With this measure of the reel diameter it is possible to control the torque of the reel shaft to give constant tension in the web. This method of tension control is an open loop technique, and relies on the system properties remaining constant over time.

Not all the torque at the shaft goes into web tension. Some of it is used to overcome losses in the mechanical system. These can be caused by:-

- Static or starting friction.
- Dynamic friction due to windage etc.
- The fixed inertia of the motor and transmission.
- The varying inertia of the increasing reel.

A torque compensation block (3.7 APPLICATION BLOCKS / TORQUE COMPENSATOR) is available to provide a compensatory signal which adds just sufficient torque to overcome the losses. For good results it is essential to keep the torque required for loss compensation as low as possible compared with that required to make tension. E. g. The torque required to overcome the losses are 10% of the torque required to provide the desired web tension. Then a drift of 25% in the losses results in a tension error of 2.5%. However if the torque required to overcome the losses is the same as the torque required to provide the desired web tension, then a drift of 25% in the losses results in a tension error of 25%. Also it will be much more difficult to estimate the absolute magnitude of the losses if they are large.

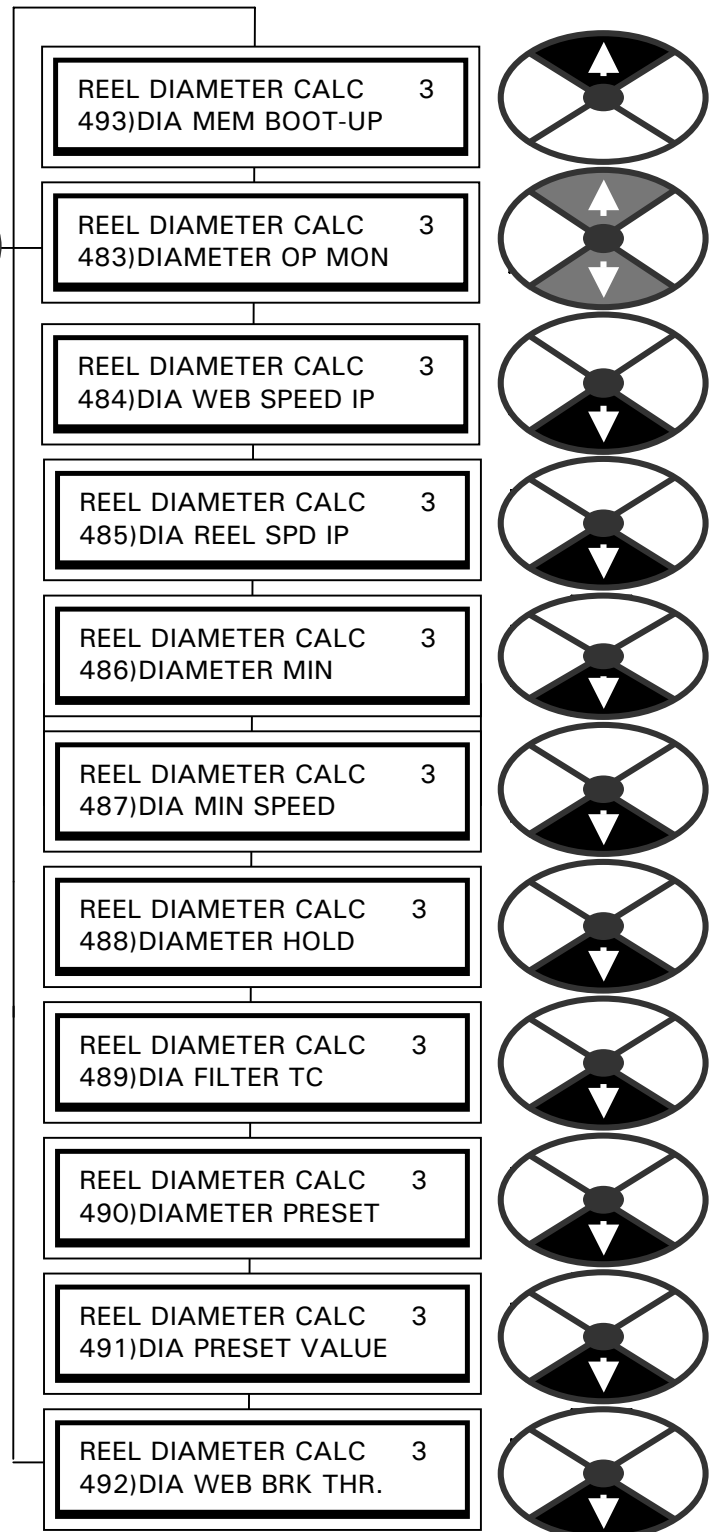

Some systems require the tension of the web to be tapered according to the reel diameter. This technique is used to prevent reel collapse or damage to delicate materials. A taper control block is available for this function. (3.6 APPLICATION BLOCKS / TAPER TENSION CALC)

If the diameter calculation is held then it is still possible to connect to a hidden PIN 697 which contains the unheld diameter calculation. Two other hidden PINs contain the rectified web and reel speeds

3.5.1 REEL DIAMETER CALC / Block diagram

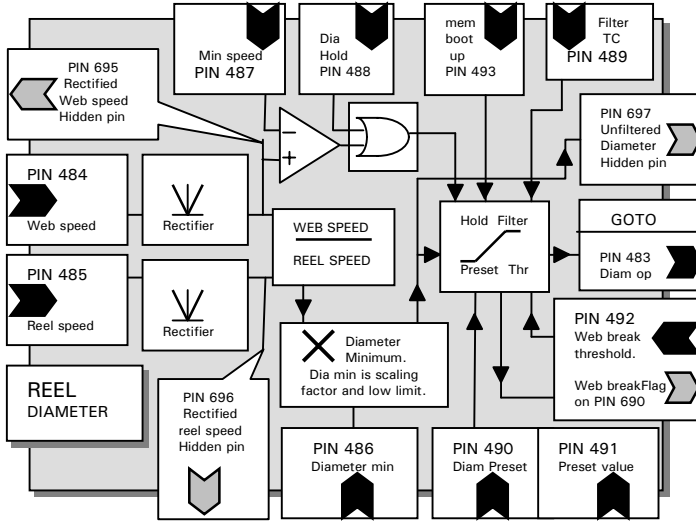

Warning. If due to the mechanical arrangement of the machine, it is impossible to achieve sufficiently low losses, then a closed loop system of tension control must be employed.

This could be by dancing arm methods or a tension transducer loadcell feedback system.

Note. This block is usually used in conjunction with the TAPER TENSION CALC and TORQUE COMPENSATOR blocks. In this case the diameter result is automatically connected to these blocks via internal software connections.

Hence the GOTO of this block must be connected to a staging post, for example, in order to activate the block.

See 3.8 Centre winding block arrangement.

3.5.2 REEL DIAMETER CALC / Diameter output monitor PIN 483

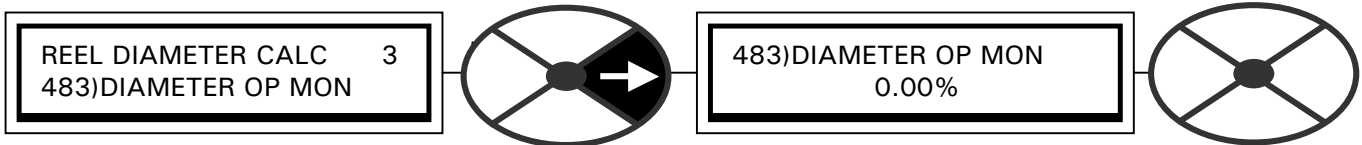

This is the output result of the diameter calculator.

PARAMETER	RANGE	DEFAULT	PIN
DIAMETER OP MON	0.00 to +100.00%	0.00%	483

3.5.3 REEL DIAMETER CALC / Web speed input PIN 484

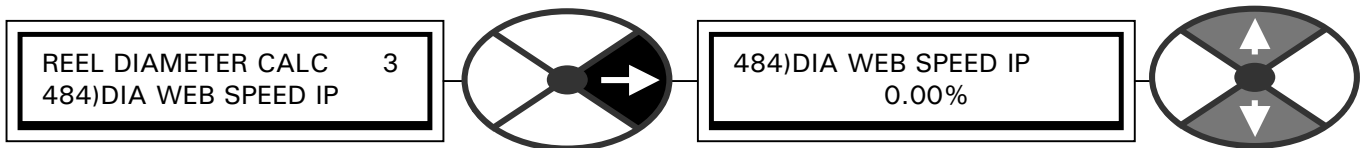

Sets the input value, prior to rectifying, for the WEB speed.

PARAMETER	RANGE	DEFAULT	PIN
DIA WEB SPEED IP	+/-105.00%	0.00%	484

3.5.4 REEL DIAMETER CALC / Reel speed input PIN 485

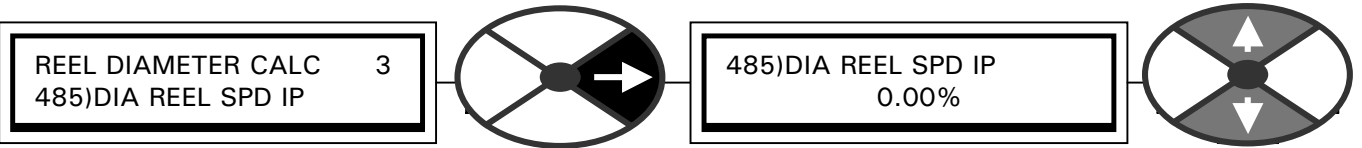

Sets the input value, prior to rectifying, for the reel speed.

PARAMETER	RANGE	DEFAULT	PIN
DIA REEL SPD IP	+/-105.00%	0.00%	485

3.5.5 REEL DIAMETER CALC / Minimum diameter input PIN 486

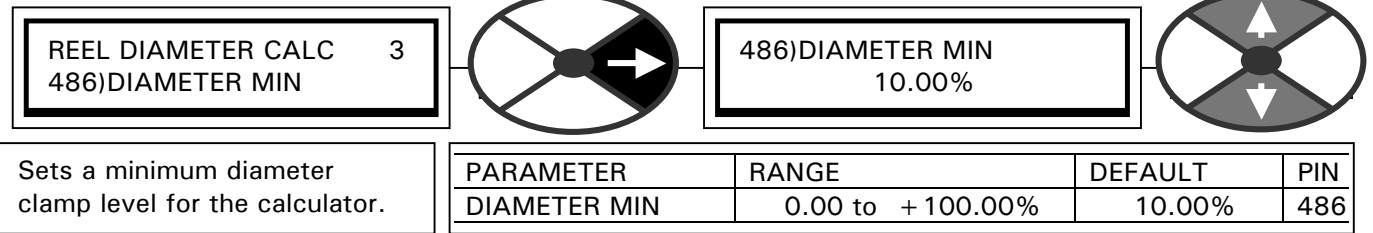

This value is also used as a scaling factor for the diameter calculation. $Result = (Web/Reel) \times (Dia\ min)$

3.5.6 REEL DIAMETER CALC / Diameter calculation min speed PIN 487

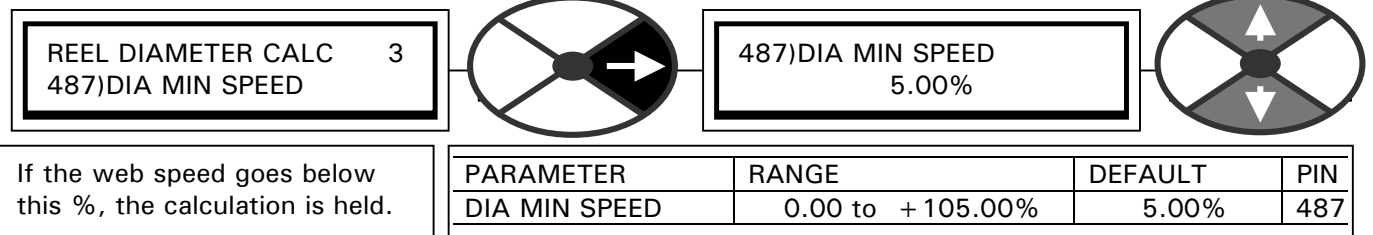

3.5.7 REEL DIAMETER CALC / Diameter hold enable PIN 488

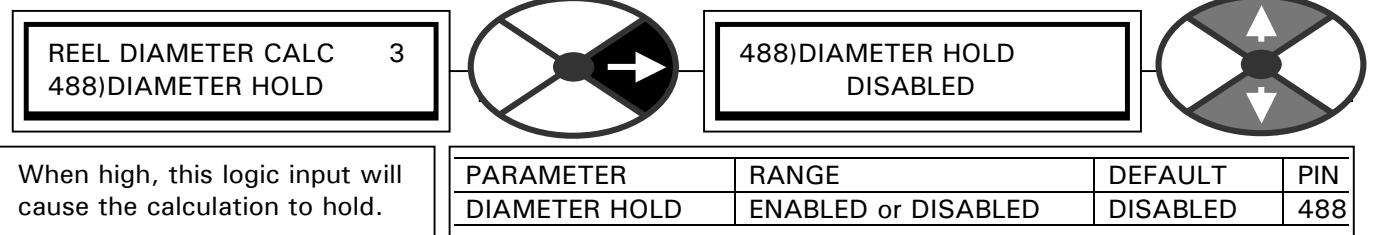

3.5.8 REEL DIAMETER CALC / Diameter filter time constant PIN 489

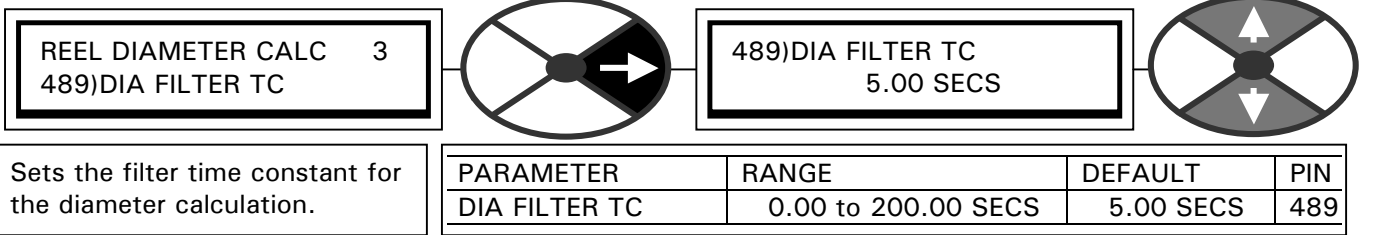

This value applies a filter to the output to remove small transients in the raw calculation. The difference between the input and output of the filter also provides a comparison measurement for the web break detector. See 3.5.11 REEL DIAMETER CALC / Diameter web break threshold PIN 492.

3.5.9 REEL DIAMETER CALC / Diameter preset enable PIN 490

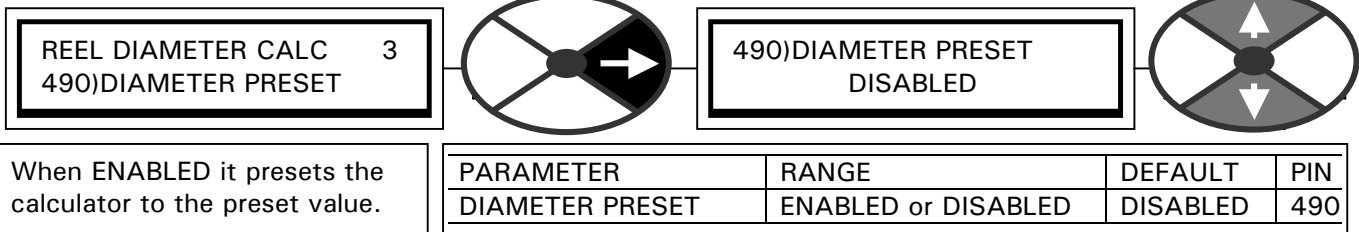

3.5.10 REEL DIAMETER CALC / Diameter preset value PIN 491

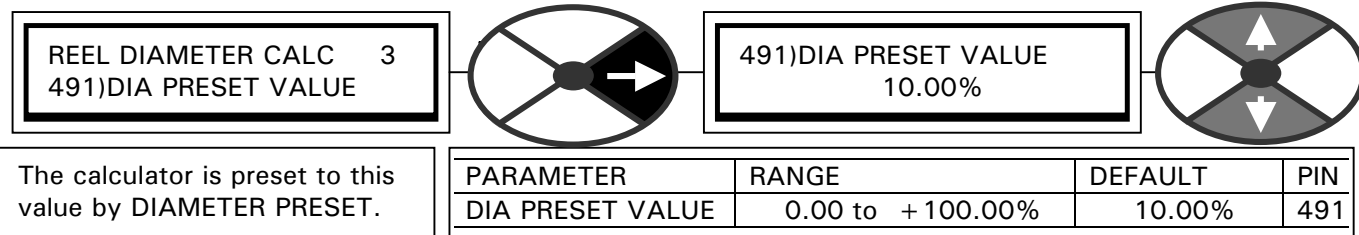

3.5.11 REEL DIAMETER CALC / Diameter web break threshold PIN 492

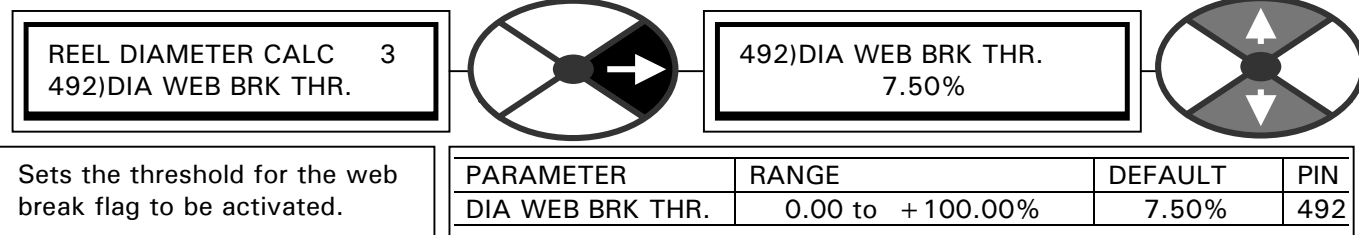

A break in the web will cause a sudden change in the diameter calculation due to the breakdown of the speed relationship. Hence if the raw calculation value changes at a rate that causes it to differ from the filtered calculation result by more than this threshold value, then the web break flag on hidden PIN 690 will be set high. See 3.5.8 REEL DIAMETER CALC / Diameter filter time constant PIN 489.

Note. This flag will also go high if the calculator output is preset to a value which differs from the calculated value, (derived from the prevailing web and reel speeds), by more than the threshold.

3.5.12 REEL DIAMETER CALC / Diameter memory boot up PIN 493

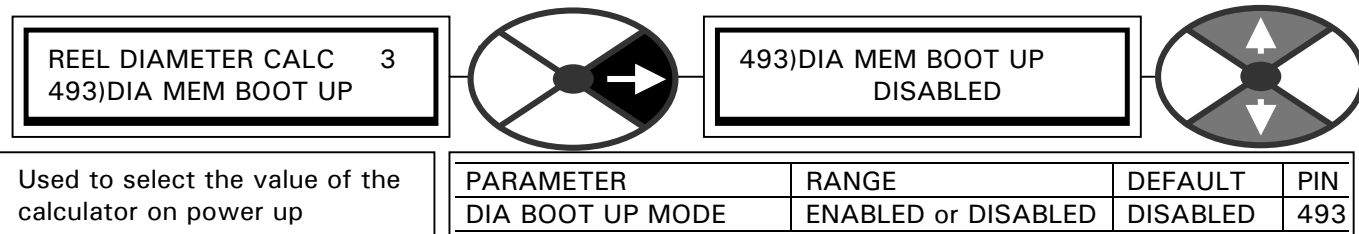

This may be used to retain the calculator value in the event of a power loss.

- 1) DISABLED Used to set the value of the calculator on control supply power up to the MIN DIAMETER.
- 2) ENABLED Used to retain the current value of the calculator during control supply power off.

3.6 APPLICATION BLOCKS / TAPER TENSION CALC

PINs used 494 to 499

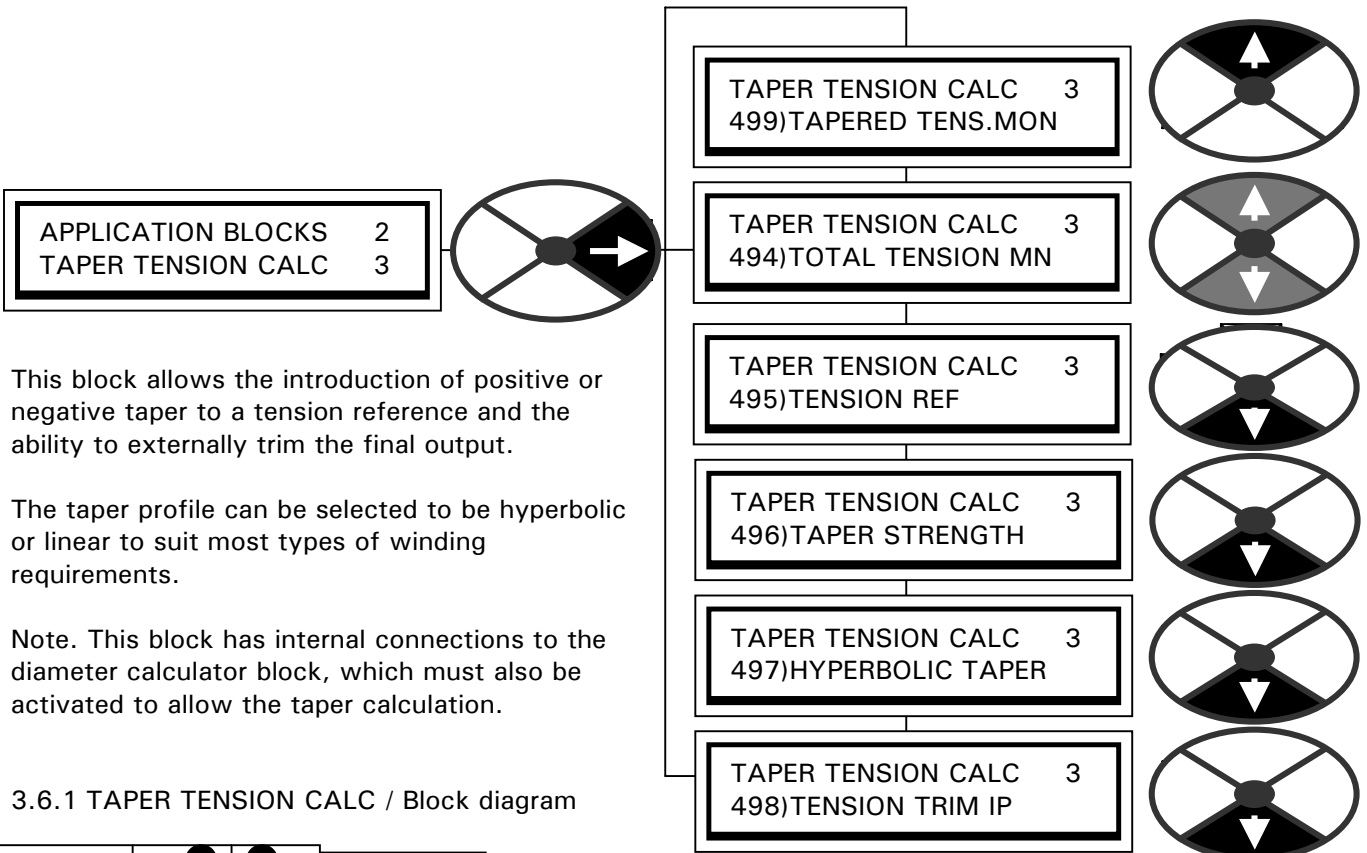

This block allows the introduction of positive or negative taper to a tension reference and the ability to externally trim the final output.

The taper profile can be selected to be hyperbolic or linear to suit most types of winding requirements.

Note. This block has internal connections to the diameter calculator block, which must also be activated to allow the taper calculation.

3.6.1 TAPER TENSION CALC / Block diagram

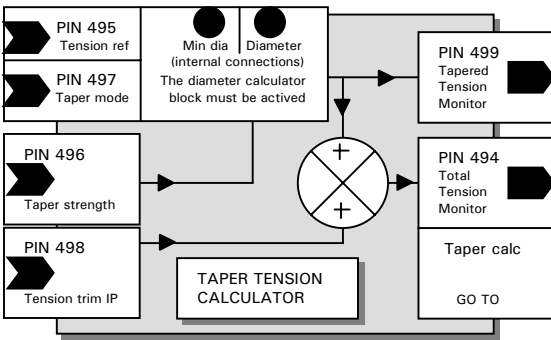

3.6.1.1 Linear taper equation

$$\text{Tapered tension\%} = (\text{Tension ref\%} / 100\%) \times (100\% - (\text{Dia\%} - \text{Min dia\%}) \times \text{Taper strength\%} / 100\%)$$

Example. Min diameter 10%, Diameter 50%, Tension ref 70%, Taper strength - 40%.

$$\begin{aligned} \text{Tapered tension\%} &= (70\% / 100\%) \times (100\% - (50\% - 10\%) \times -40\% / 100\%) \\ &= 0.7 \times (100\% - (40\% \times -0.4)) \\ &= 0.7 \times (100\% - (-16\%)) \\ &= 0.7 \times 116\% \\ &= 81.20\% \end{aligned}$$

3.6.1.2 Hyperbolic taper equation

$$\text{Tapered tension\%} = (\text{Tension ref\%} / 100\%) \times (100\% - (\text{Dia\%} - \text{Min dia\%}) \times \text{Taper strength\%} / \text{Dia\%})$$

3.6.1.3 Taper graphs showing tension versus diameter

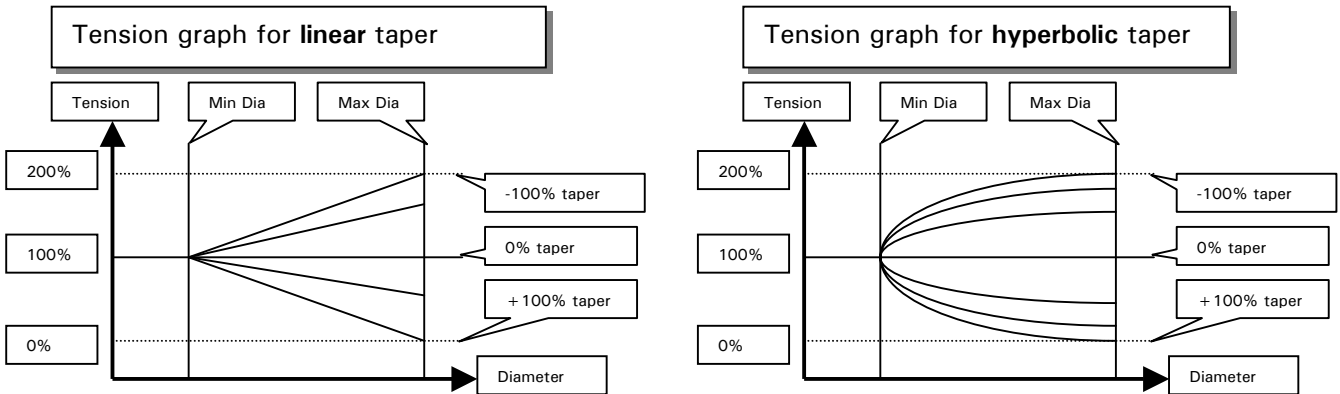

3.6.1.4 Taper graphs showing torque versus diameter

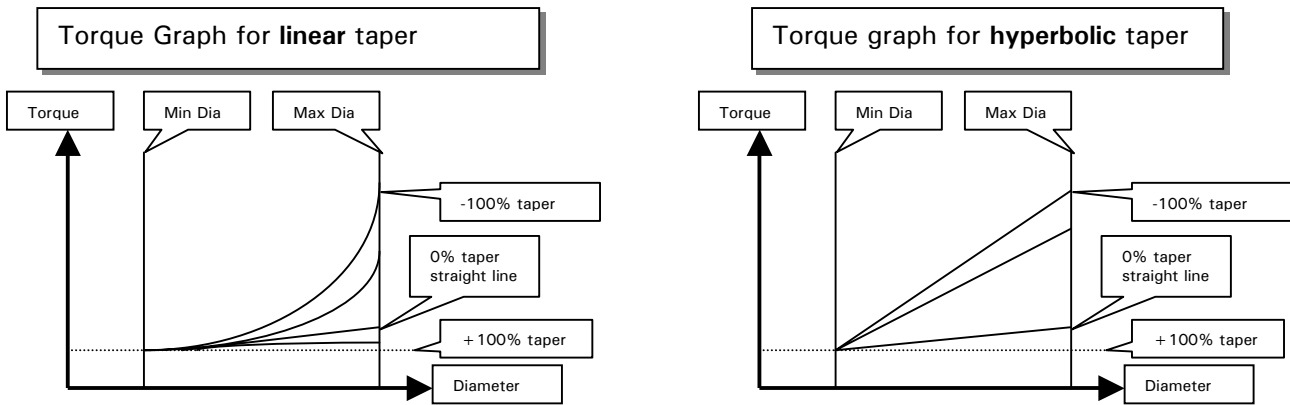

3.6.2 TAPER TENSION CALC / Total tension OP monitor PIN 494

TAPER TENSION CALC 3
494)TOTAL TENSION MN

494)TOTAL TENSION MN
0.00%

This is the total output of the taper tension calculator.

PARAMETER	RANGE	PIN
TOTAL TENSION MN	+/-100.00%	494

This has a branch hopping facility to 3.6.7 TAPER TENSION CALC / Tapered tension monitor PIN 499.

3.6.3 TAPER TENSION CALC / Tension reference PIN 495

TAPER TENSION CALC 3
495)TENSION REF

495)TENSION REF
0.00%

This is the tension reference for the taper tension calculator

PARAMETER	RANGE	DEFAULT	PIN
TENSION REF	0.00 to +100.00%	0.00%	495

3.6.4 TAPER TENSION CALC / Taper strength input PIN 496

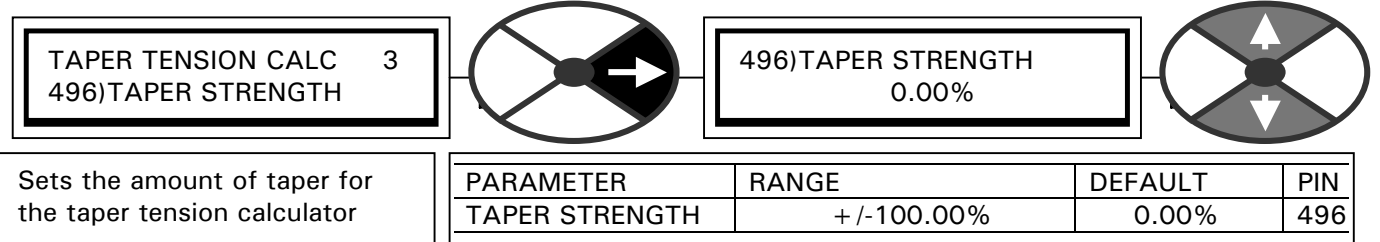

Note. +100.00% taper progressively reduces the tension to zero at full diameter.

0.00% taper gives constant tension over the entire diameter range.

-100.00% taper progressively increases the tension to 200.00% at full diameter.

The taper may be linear or hyperbolic. See 3.6.5 TAPER TENSION CALC / Hyperbolic taper enable PIN 497.

3.6.5 TAPER TENSION CALC / Hyperbolic taper enable PIN 497

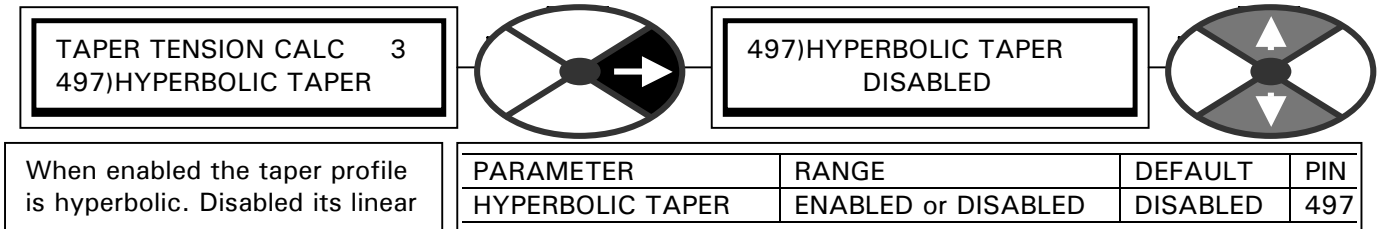

See 3.6.4 TAPER TENSION CALC / Taper strength input PIN 496.

3.6.6 TAPER TENSION CALC / Tension trim input PIN 498

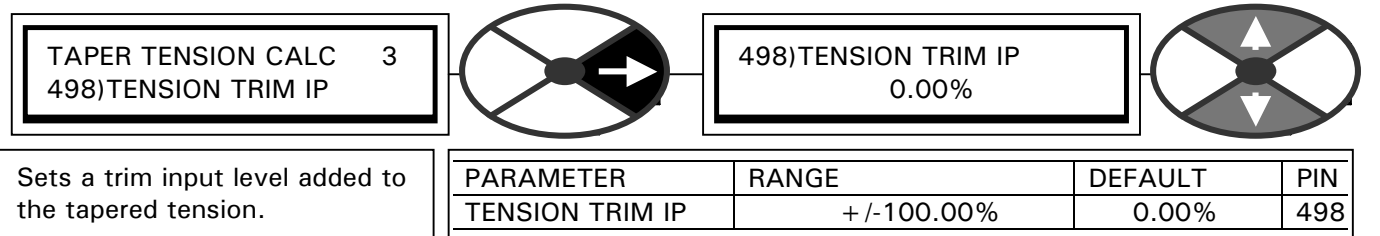

3.6.7 TAPER TENSION CALC / Tapered tension monitor PIN 499

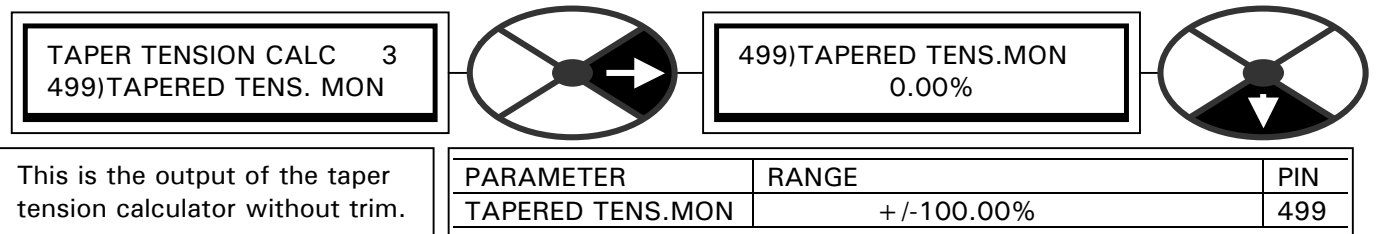

This has a branch hopping facility to 3.6.2 TAPER TENSION CALC / Total tension OP monitor PIN 494

3.7 APPLICATION BLOCKS / TORQUE COMPENSATOR

PINs used 500 to 520

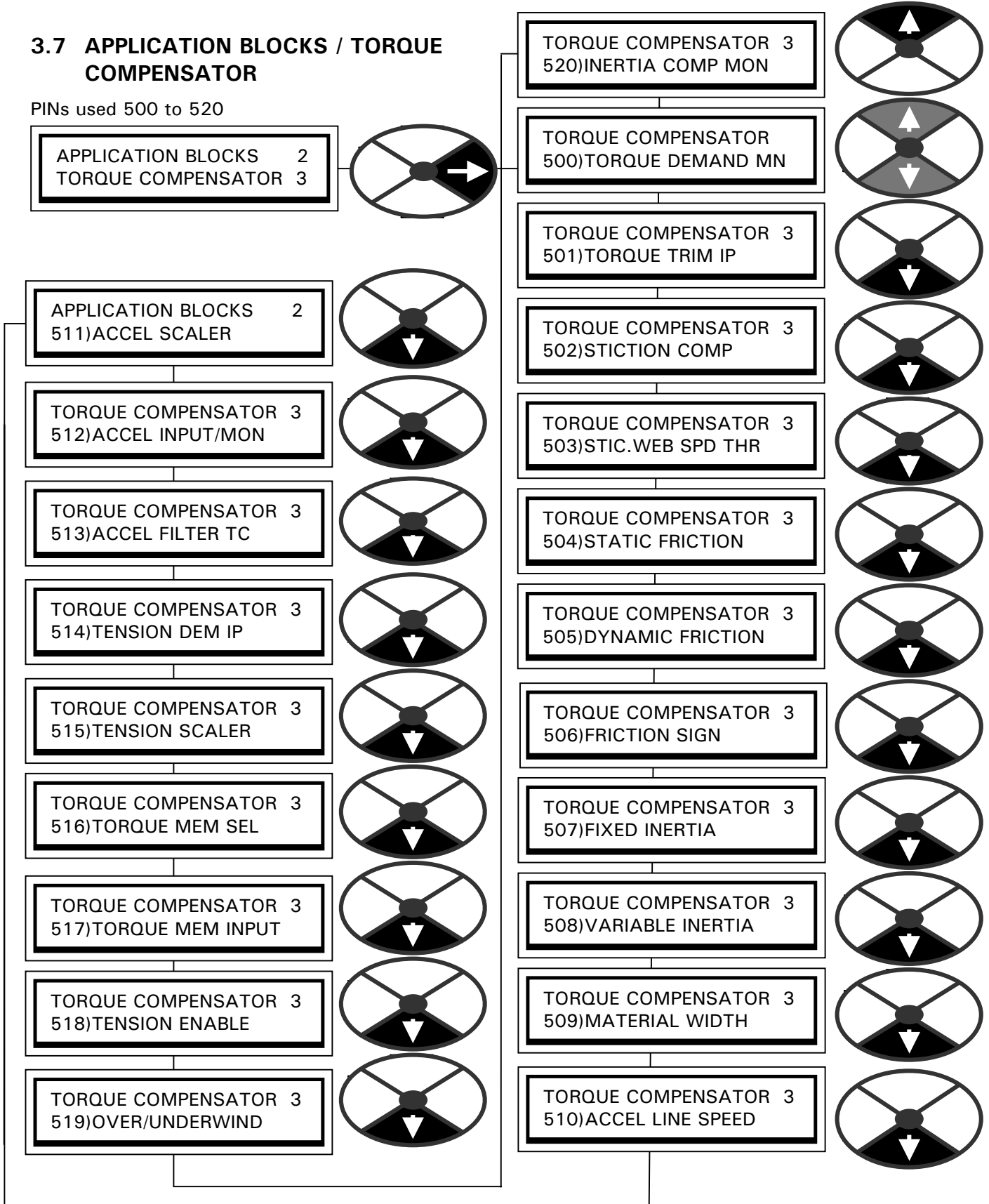

This block is used to add loss compensation to the tension demand signal generated by the TAPER TENSION CALC block. The result is steered to the positive or negative current limits to provide a torque clamp which will give the correct tension. The losses in the winding system are friction and inertia.

When winding, the drive system relies on arranging the speed loop to saturate. This means that under all running conditions the speed demand remains unsatisfied, and hence is always asking for more current than the clamps will allow. Hence the current is operating at the limit determined by the torque compensator. The speed loop saturation may be accomplished by utilising the SLACK take up function. See JOG CRAWL SLACK in the main manual. There is a hidden PIN, 714)IN SLACK FLAG, which stays high during the slack take up mode including the ramp up/down periods. This FLAG can be used to operate 518)TENSION ENABLE.

Friction. The block provides compensation for stiction, static friction and dynamic friction. Stiction compensation is applied only if the web speed exceeds its programmed threshold (e. g. 5%) and the reel speed remains below 2%. This compensation is used to get the system moving. Static friction compensation is applied at a constant level throughout the speed range. Dynamic friction compensation is applied throughout the speed range and linearly increases with speed.

Inertia. When accelerating positively or negatively (decelerating), torque is required to overcome the mechanical inertia of the total load. Without compensation this torque is no longer available to provide tension. Hence to control the tension more accurately the block provides compensation for both fixed and variable inertia. The fixed inertia compensation is used to accelerate all fixed mass components of the system (e. g. motor, gearbox, reel former etc.). The variable inertia compensation is used to accelerate the process material, the mass of which is changing as the reel diameter changes. There is also provision for compensating for different material widths.

The compensation factors may be found by pure calculation, or empirically. The descriptions here outline empirical methods that may be utilised using only the reel drive, and a full and empty reel.

3.7.1 TORQUE COMPENSATOR / Block diagram

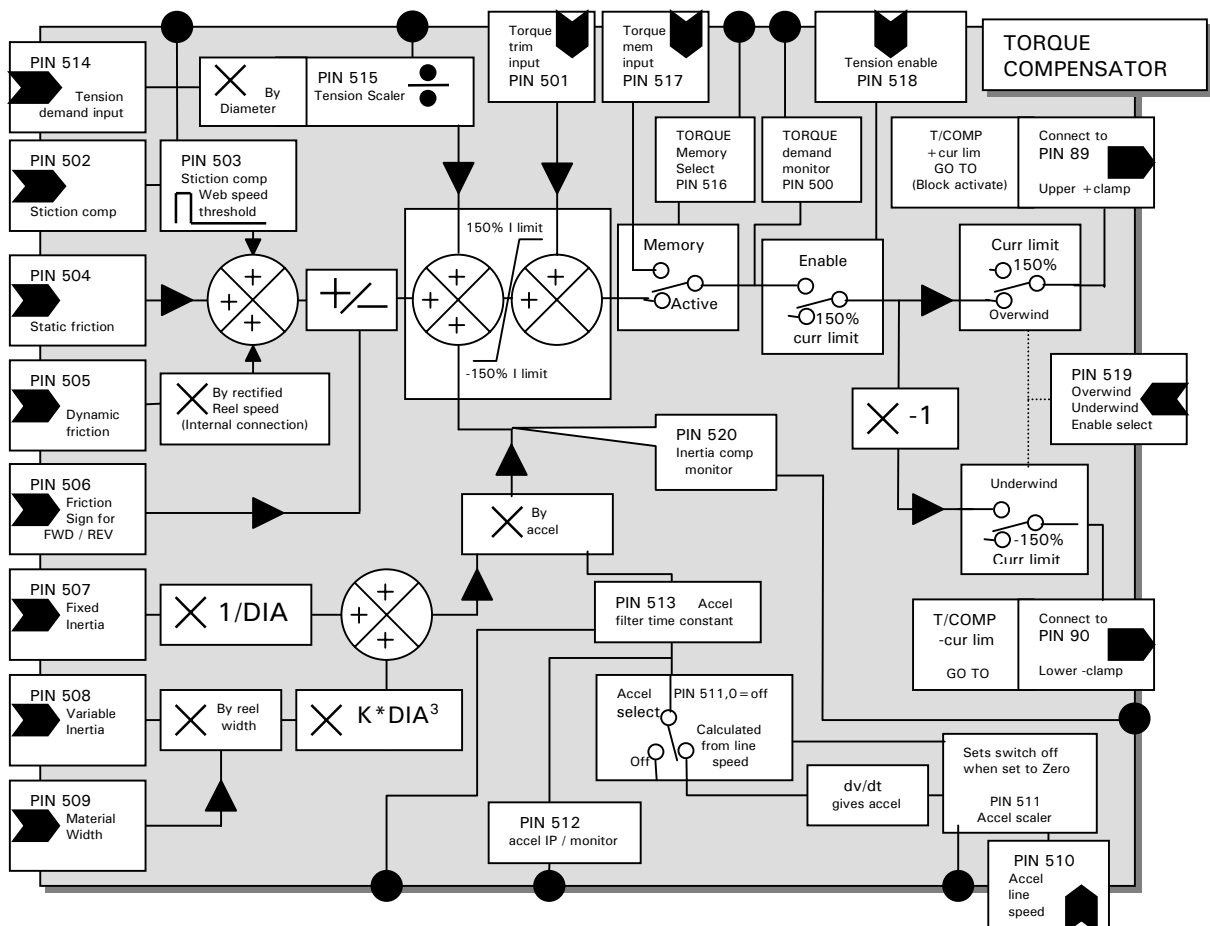

3.7.2 TORQUE COMPENSATOR / Torque demand monitor PIN 500

TORQUE COMPENSATOR 3
500)TORQUE DEMAND MN

500)TORQUE DEMAND MN
0.00%

Allows the torque demand reference to be monitored.

PARAMETER	RANGE	DEFAULT	PIN
TORQUE DEMAND MN	+/-300.00%	0.00%	500

The torque demand reference is the sum of all the compensation components and the scaled tension demand. This has a branch hopping facility to 3.7.22 TORQUE COMPENSATOR / Inertia comp monitor PIN 520.

3.7.3 TORQUE COMPENSATOR / Torque trim input PIN 501

TORQUE COMPENSATOR 3
501)TORQUE TRIM IP

501)TORQUE TRIM IP
0.00%

Allows a torque trim input to be added to the compensation.

PARAMETER	RANGE	DEFAULT	PIN
TORQUE TRIM IP	+/-150.00%	0.00%	501

3.7.4 TORQUE COMPENSATOR / Stiction compensation PIN 502

TORQUE COMPENSATOR 3
502)STICTION COMP

502)STICTION COMP
0.00%

Sets the level of compensation required to overcome stiction.

PARAMETER	RANGE	DEFAULT	PIN
STICTION COMP	+/-300.00%	0.00%	502

See 3.7.5 TORQUE COMPENSATOR / Stiction web speed threshold PIN 503.

3.7.5 TORQUE COMPENSATOR / Stiction web speed threshold PIN 503

TORQUE COMPENSATOR 3
503)STIC.WEB SPD THR

503)STIC.WEB SPD THR
5.00%

Sets the WEB speed above which stiction comp occurs.

PARAMETER	RANGE	DEFAULT	PIN
STIC.WEB SPD THR	0.00 to 10.00%	5.00%	503

Some systems require extra torque to overcome starting friction. This level must be set to ensure the reel motor starts rotating. The system will add the compensation set in 3.7.4 TORQUE COMPENSATOR / Stiction compensation PIN 502, when the web speed reference is greater than the threshold AND the reel speed feedback is less than 2.00%. Hence the compensation is only active during the stiction phase, and will not be permanently applied at zero web speed reference. The threshold is not signed and is applied to both directions of rotation. A value of 5.00% is suggested as a starting point.

3.7.6 TORQUE COMPENSATOR / Static friction compensation PIN 504

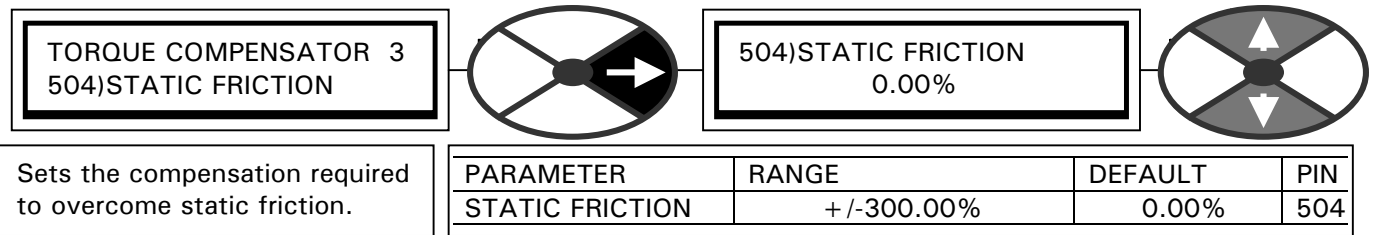

This compensation is applied at a constant level throughout the speed range. With an empty reel running at 10% speed, observe the ARM CUR % MON in the diagnostics menu. Enter the monitored value here.

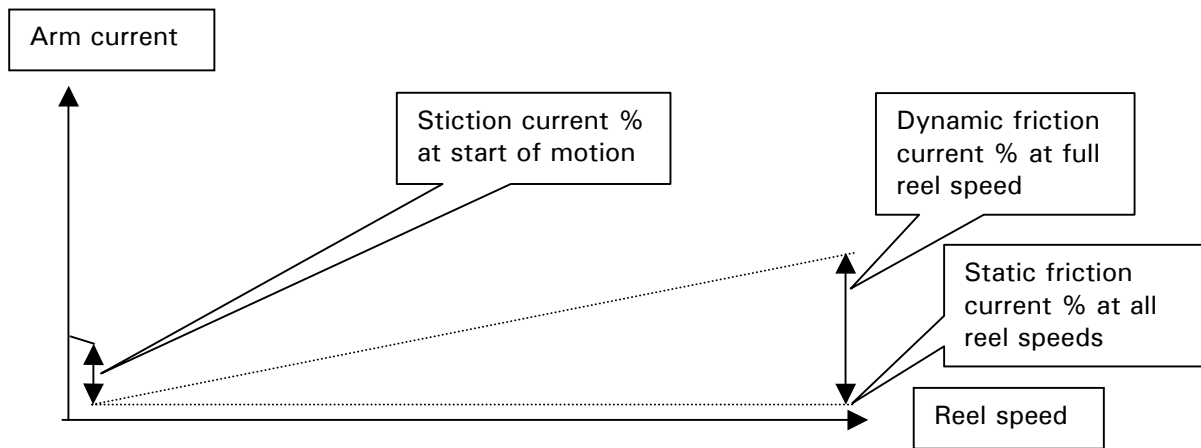

3.7.7 TORQUE COMPENSATOR / Dynamic friction compensation PIN 505

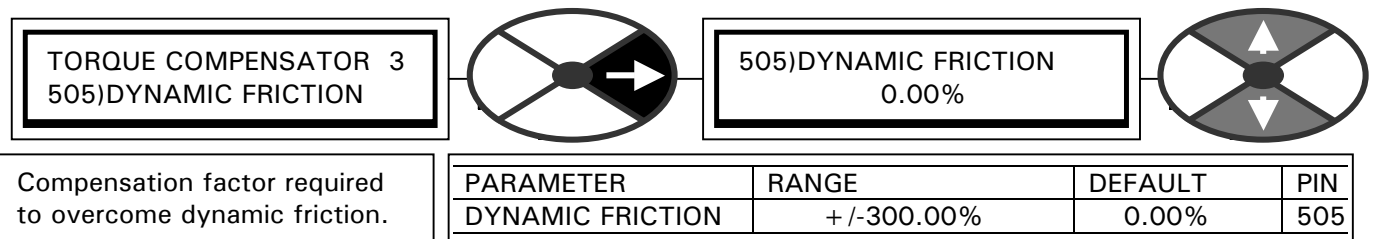

This compensation is applied at a level proportional to speed. With an empty reel running at 100% speed, observe the ARM CUR % MON in the diagnostics menu. Enter the difference between the monitored value and 504)STATIC FRICTION. The block automatically adjusts the compensation by scaling it according to web speed.

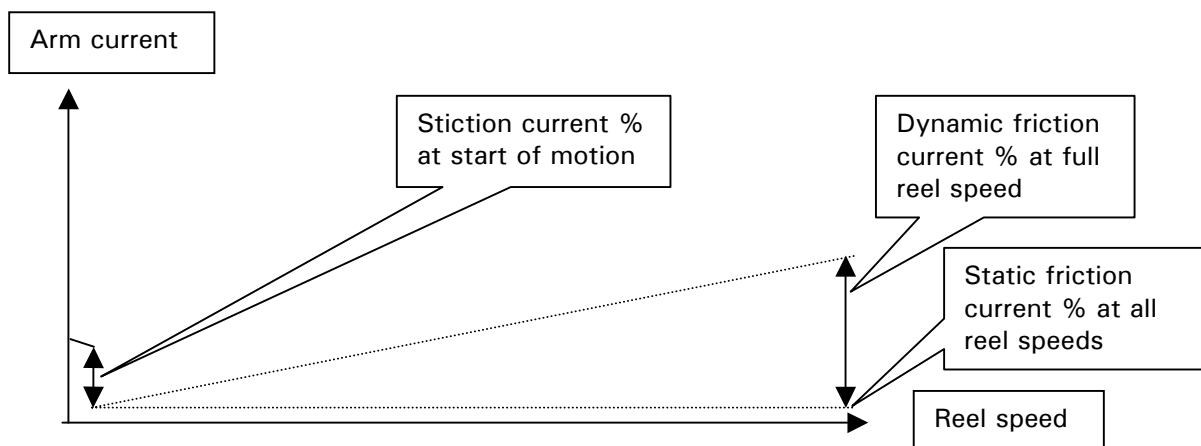

3.7.8 TORQUE COMPENSATOR / Friction sign PIN 506

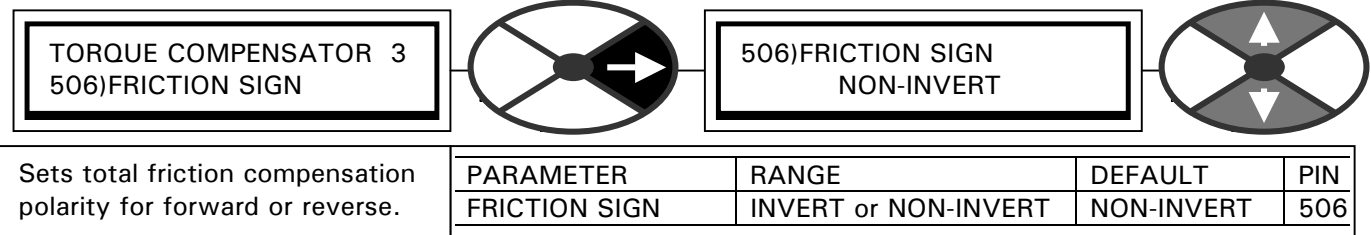

3.7.9 TORQUE COMPENSATOR / Fixed mass inertia PIN 507

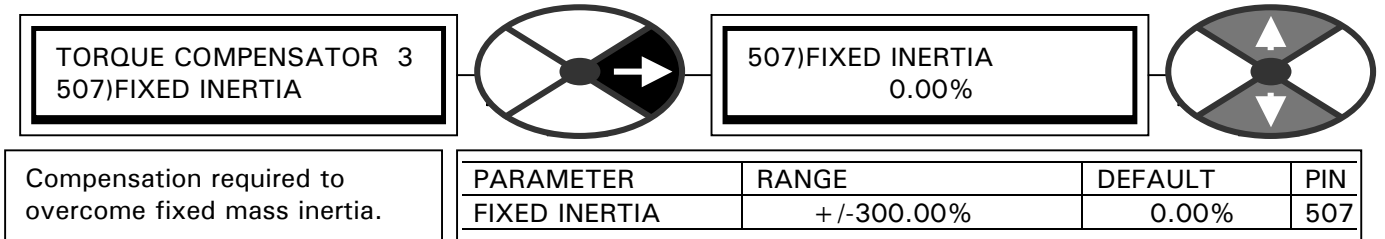

The compensation applied depends on reel diameter. The diameter calculator block must be activated in order for the diameter value to be acquired by this block.

The gain of this input is proportional to $1/DIA$. It is unity for minimum diameter and $1/(\text{build up ratio})$ at maximum diameter.

To arrive at a suitable value to enter here you must perform a measurement of armature current with a separate empty reel running in speed control mode. First reprogram the reel drive speed ramp to the same ramp time as the web speed. Then set the speed to a constant 95% and note ARM CUR % MON in the diagnostics menu. Increase the speed reference to 100%, while the reel is ramping up to the new speed measure the increased ARM CUR % MON in the diagnostics menu. The **change** is the current% required to accelerate the fixed mass to the new speed at the normal maximum acceleration rate. Enter this change in current% in the FIXED INERTIA window.

If differing reel core sizes or masses are to be used, the fixed mass inertia value must be determined and then used for each reel core for complete accuracy.

The fixed inertia compensation has the greatest influence on tension accuracy for empty reels. In this case the speeds are higher and the ratio of fixed mass to variable mass is also higher. Hence for good results it is important to make accurate measurements to determine the compensation.

3.7.10 TORQUE COMPENSATOR / Variable mass inertia PIN 508

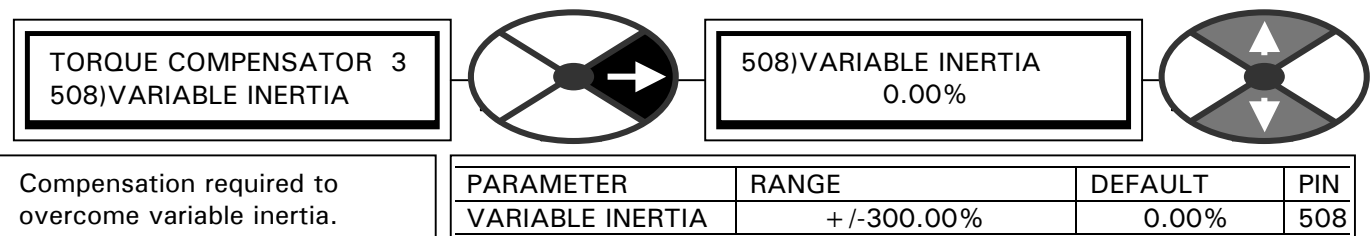

The compensation applied depends on reel diameter. The diameter calculator block must be activated in order for the diameter value to be acquired by this block.

The gain curve of this input is proportional to DIA^3 . It is zero at minimum diameter and unity for maximum diameter. To arrive at a suitable value to enter here you must perform a measurement of armature current

with a separate **full** reel running in speed control mode. The purpose of this experiment is to simulate the condition of unity gain to this input and measure the torque required to accelerate the mass. This condition occurs at maximum diameter and hence minimum reel speed. First calculate the build up ratio. E. g. If your core diameter is 0.1 metre, and the full reel diameter is 0.5 metre, then the build up ratio is 5.

1) Then reprogram the reel drive speed ramp to a new longer ramp time as follows
 New ramp time = the web speed ramp time **X** the build up ratio.

E. g. For a web speed ramp time of 10 secs and a build up ratio of 5. Adjust the reel speed ramp time to 50 secs for the duration of the experiment. Remember to return the reel speed ramp time to the original setting after the reading has been completed.

2) Set the speed of the reel drive to 100% / Build up ratio. (in this example this results in a 20% speed)

Then, increase the speed reference by 5%. Note the **change** in ARM CUR % MON in the diagnostics menu whilst the reel of material is accelerating. Make a note of this value and then subtract an amount equal to 507)FIXED INERTIA, and the result represents the current% required to accelerate the mass of the material. Enter this value.

3.7.11 TORQUE COMPENSATOR / Material width PIN 509

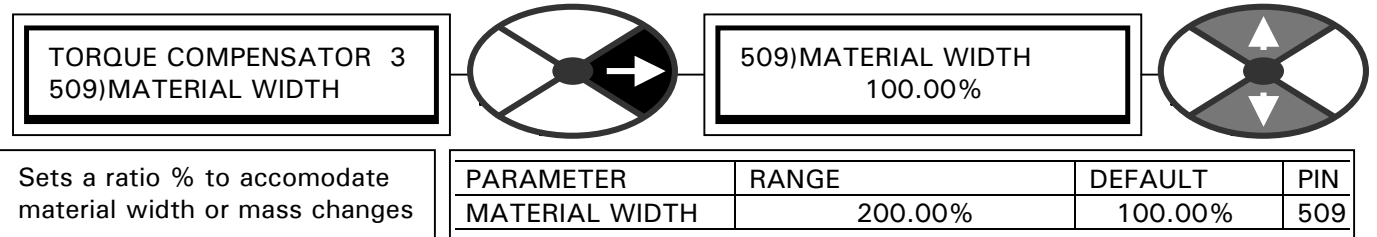

The material used during empirical measurement of inertia compensation currents is the 100% width/mass.

E. g. For material twice as wide as the measurement material this value should be set to 200.00%
 For material of a specific gravity which is 80% of the measurement material, set the value to 80.00%.
 For material of a specific gravity which is 80% of the measurement material, and twice as wide, set the value to 160.00%.

Note. The formula used by the block assumes an air core. The mass of the reel core is accommodated in the value for fixed mass inertia compensation. If the reel mass changes aswell as the material, then both FIXED INERTIA and MATERIAL WIDTH parameters will need adjusting.

3.7.12 TORQUE COMPENSATOR / Accel line speed input PIN 510

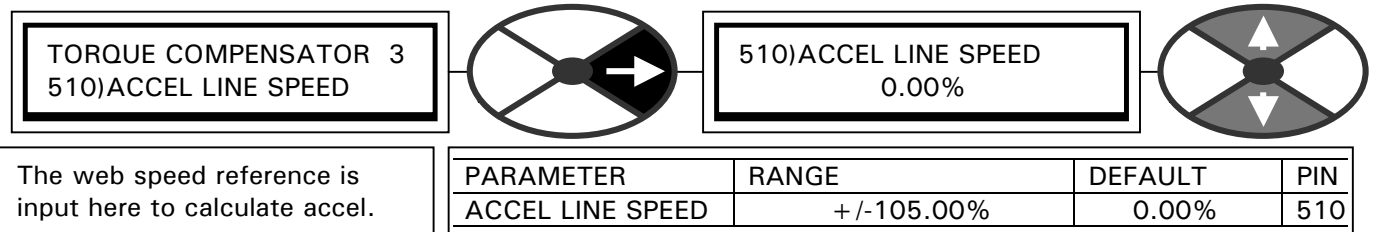

The acceleration of the system is required in order to calculate the total inertia compensation. There are two ways of arriving at a value for acceleration.

- 1) Input the acceleration value directly from an external source to PIN 512.
- 2) Let the block calculate the value by differentiating the line or web speed which is input to PIN 510.

When using method 2 a line or web speed reference is input. Note. The line speed reference will usually come from an external source via an analogue input terminal.

The input speed is scaled by PIN 511)ACCEL SCALER.

Note. If PIN 511)ACCEL SCALER is set to 0.00 then an internal switch is opened to allow 512)ACCEL INPUT/MON to become an input. Otherwise it remains a monitor of the calculated accel.

The resulting value on 512)ACCEL INPUT/MON should be arranged to be 100.00% for maximum acceleration by either method.

3.7.13 TORQUE COMPENSATOR / Accel scaler PIN 511

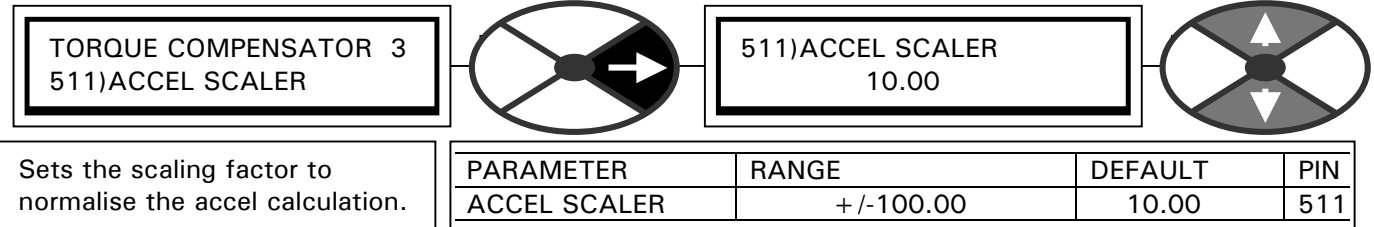

Typically set this value to equal the 100% ramp time. E.g. Total ramp time equal 10 secs. Set to 10.00.

See 3.7.12 TORQUE COMPENSATOR / Accel line speed input PIN 510

Note. If PIN 511)ACCEL SCALER is set to 0.00 then an internal switch is opened to allow 512)ACCEL INPUT/MON to become an input. Otherwise it remains a monitor of the calculated accel.

3.7.14 TORQUE COMPENSATOR / Accel input/monitor PIN 512

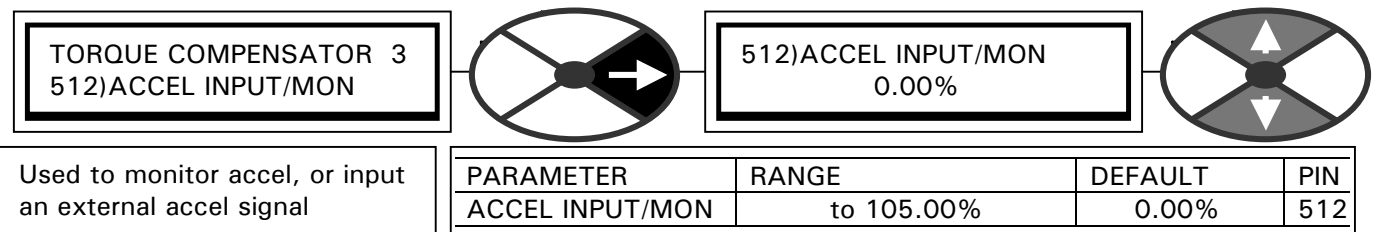

See 3.7.12 TORQUE COMPENSATOR / Accel line speed input PIN 510

3.7.15 TORQUE COMPENSATOR / Accel filter time constant PIN 513

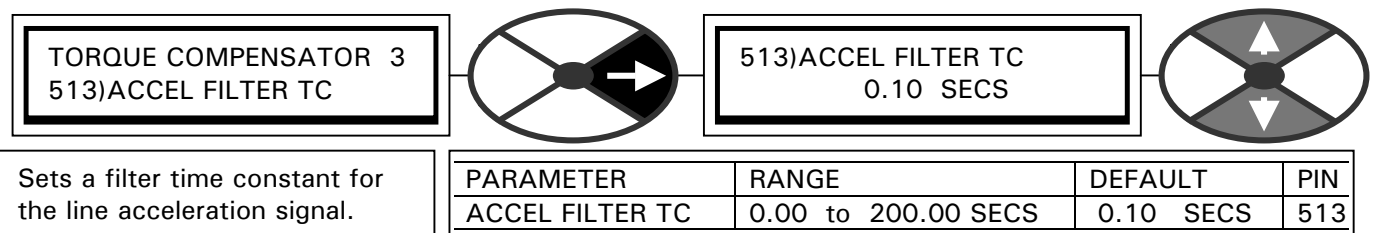

If the line speed input or the external accel input signal used to derive the accel value have a ripple content then this may cause tension variations. The filter is provided to smooth the accel value. Use the accel monitor to set the filter time constant. Select the lowest filter time constant that gives a smooth accel value.

3.7.16 TORQUE COMPENSATOR / Tension demand input PIN 514

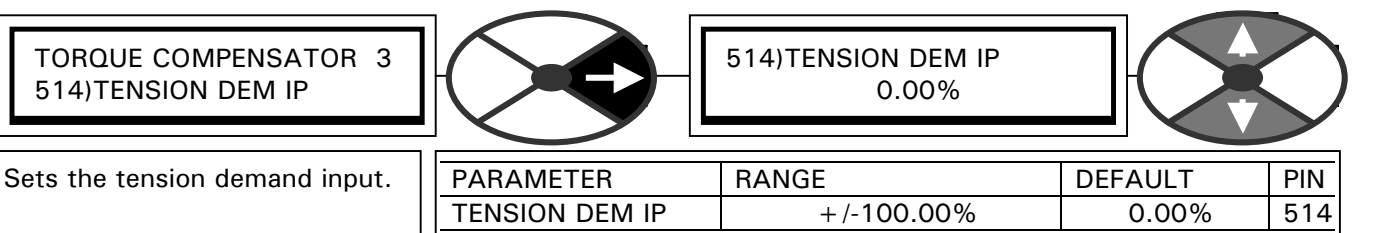

3.7.17 TORQUE COMPENSATOR / Tension scaler PIN 515

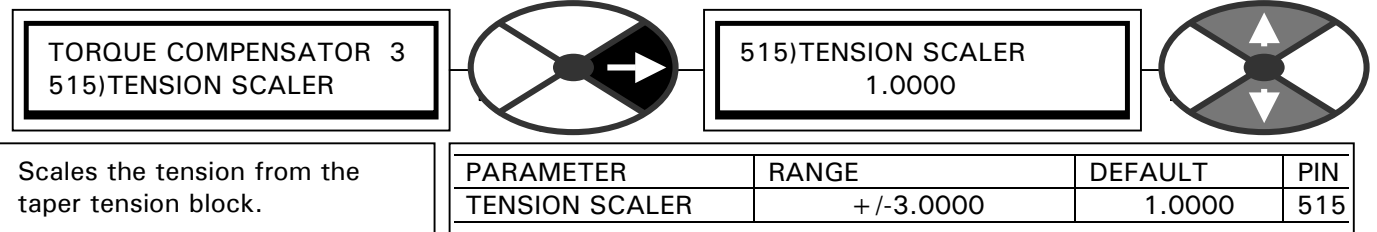

The result of the product of the tension input and the diameter are divided by the factor entered here.

3.7.18 TORQUE COMPENSATOR / Torque memory select PIN 516

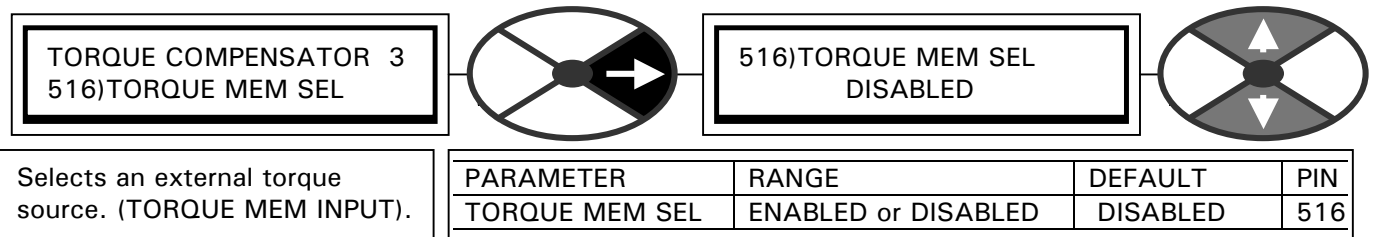

This is useful if the torque is required to be held at a memorised value while the input speeds are not available at the levels required to provide a calculated output. Eg. During a reel changeover sequence. The memorised value may be obtained using a sample and hold. See 3.10 APPLICATION BLOCKS / MULTI-FUNCTION 1 to 8.

3.7.19 TORQUE COMPENSATOR / Torque memory input PIN 517

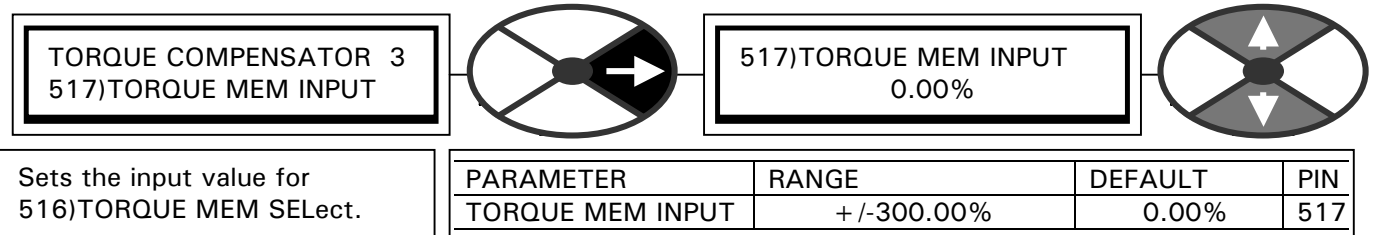

This is useful if the torque is required to be held at a memorised value while the input speeds are not available at the levels required to provide a calculated output. Eg. During a line stopping sequence. The memorised value may be obtained using a sample and hold. See 3.10 APPLICATION BLOCKS / MULTI-FUNCTION 1 to 8.

3.7.20 TORQUE COMPENSATOR / Tension enable PIN 518

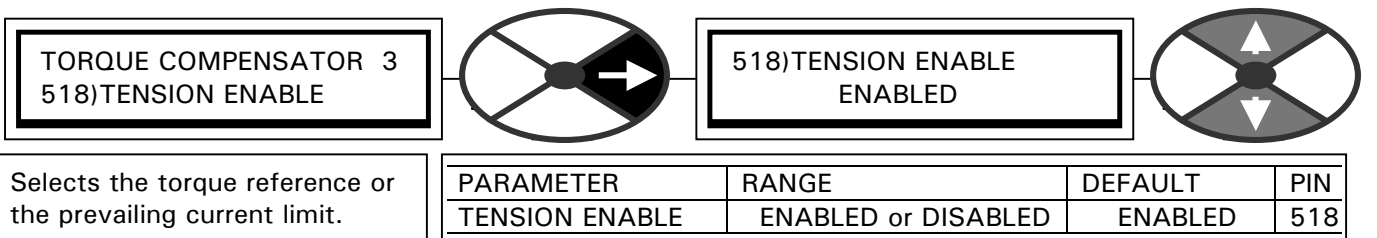

By selecting the prevailing current limit (DISABLED), the system can operate as a speed controller. When the torque demand is ENABLED the torque compensator provides the new current limit.

When winding, the drive system relies on arranging the speed loop to saturate so that the current is operating at the limit determined by the torque compensator. The speed loop saturation may be accomplished by utilising the SLACK take up function. See JOG CRAWL SLACK in the main manual.

There is a hidden PIN, 714)IN SLACK FLAG, which stays high during the slack take up mode including the ramp up/down periods. This FLAG can be used to operate 518)TENSION ENABLE.

3.7.21 TORQUE COMPENSATOR / Overwind/underwind PIN 519

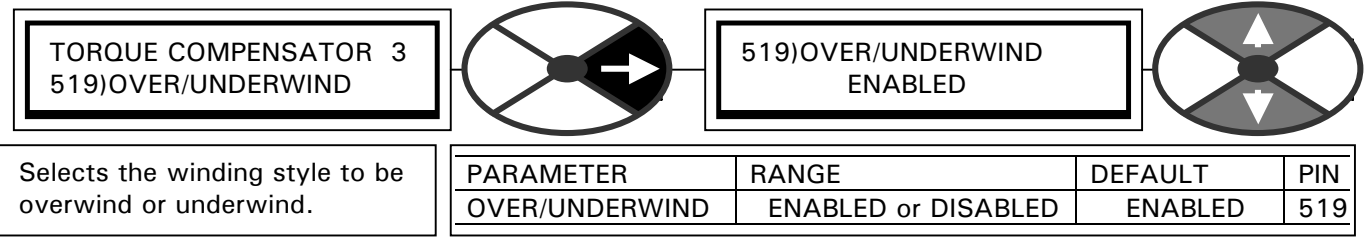

Overwinding is selected when the function is enabled. Underwind is selected when the function is disabled.

The term overwinding is referring to the chosen direction of layer addition on the reel. It assumes that the web is wound onto the reel in the direction which requires a positive current clamp. If the web is wound on in the underwind direction then the reel must change direction of rotation and the negative current clamp is operative.

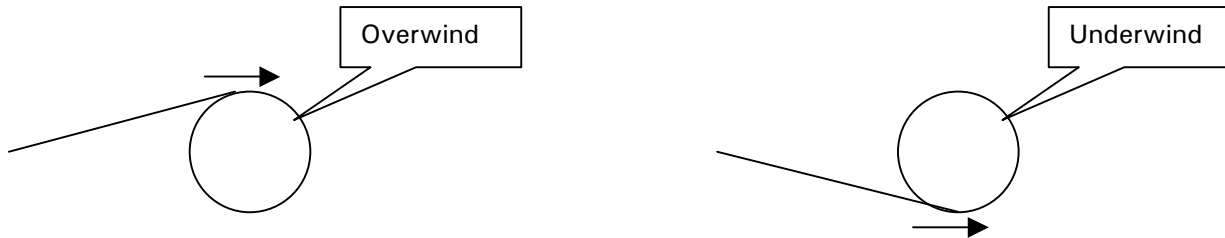

3.7.22 TORQUE COMPENSATOR / Inertia comp monitor PIN 520

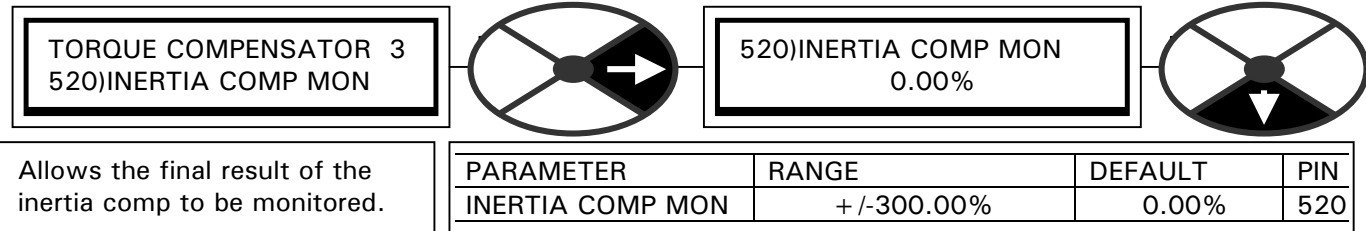

This has a branch hopping facility to 3.7.2 TORQUE COMPENSATOR / Torque demand monitor PIN 500.

3.8 Centre winding block arrangement

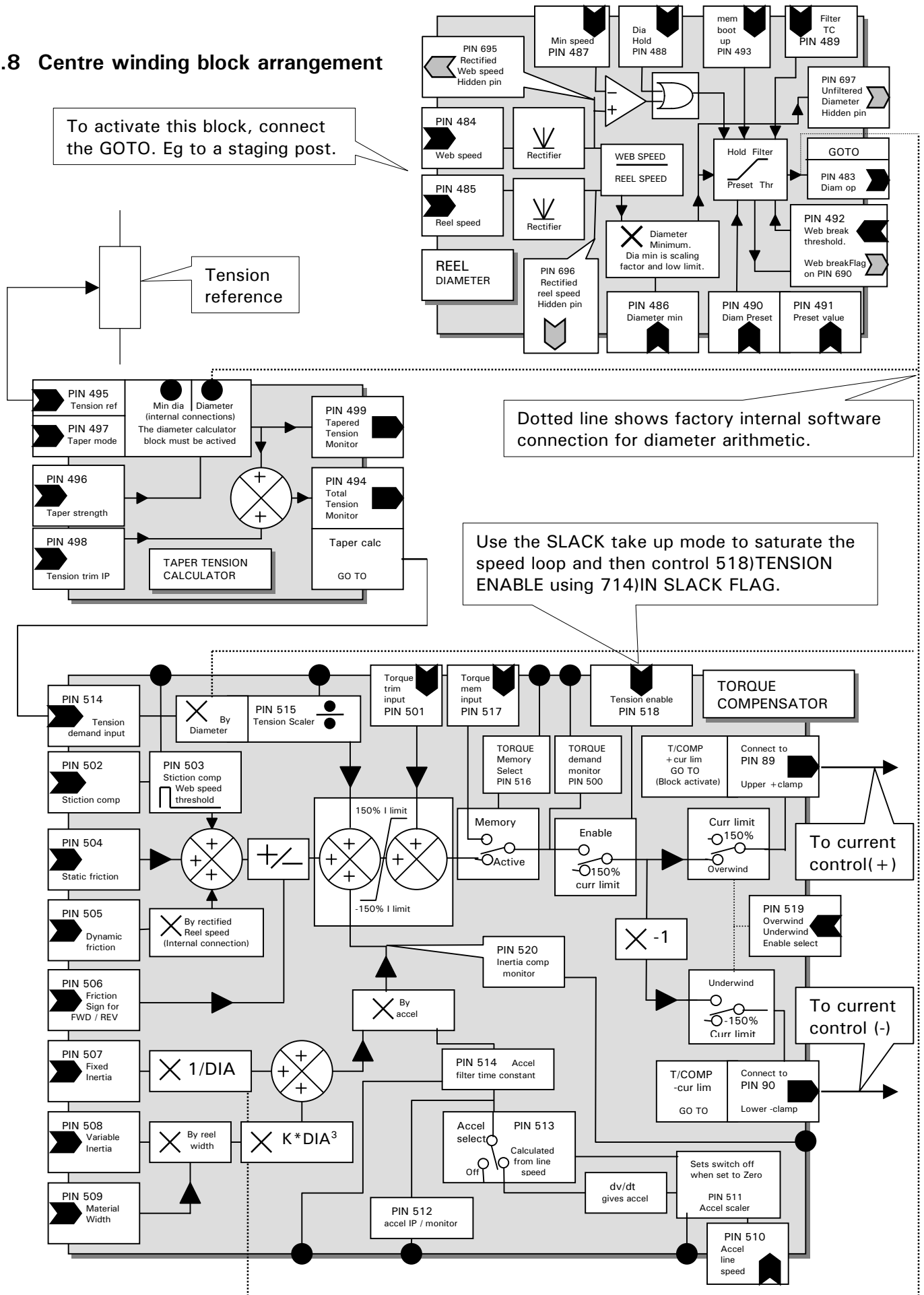

3.9 APPLICATION BLOCKS / PRESET SPEED

Pin numbers used 523 to 534

APPLICATION BLOCKS	2
PRESET SPEED	3

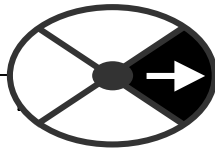

This block provides a versatile preset value selection machine. The primary use is for preset speeds. By defining output values for each one of 8 possible input combinations, various types of preset mode are possible. E. g. Input priority, input summing, BCD thumbwheel code.

This block contains 8 consecutive PINs with a range of +/-300.00% (527 to 534). If the block is not being used for its intended function then these PINs are ideal as extra STAGING POSTS.

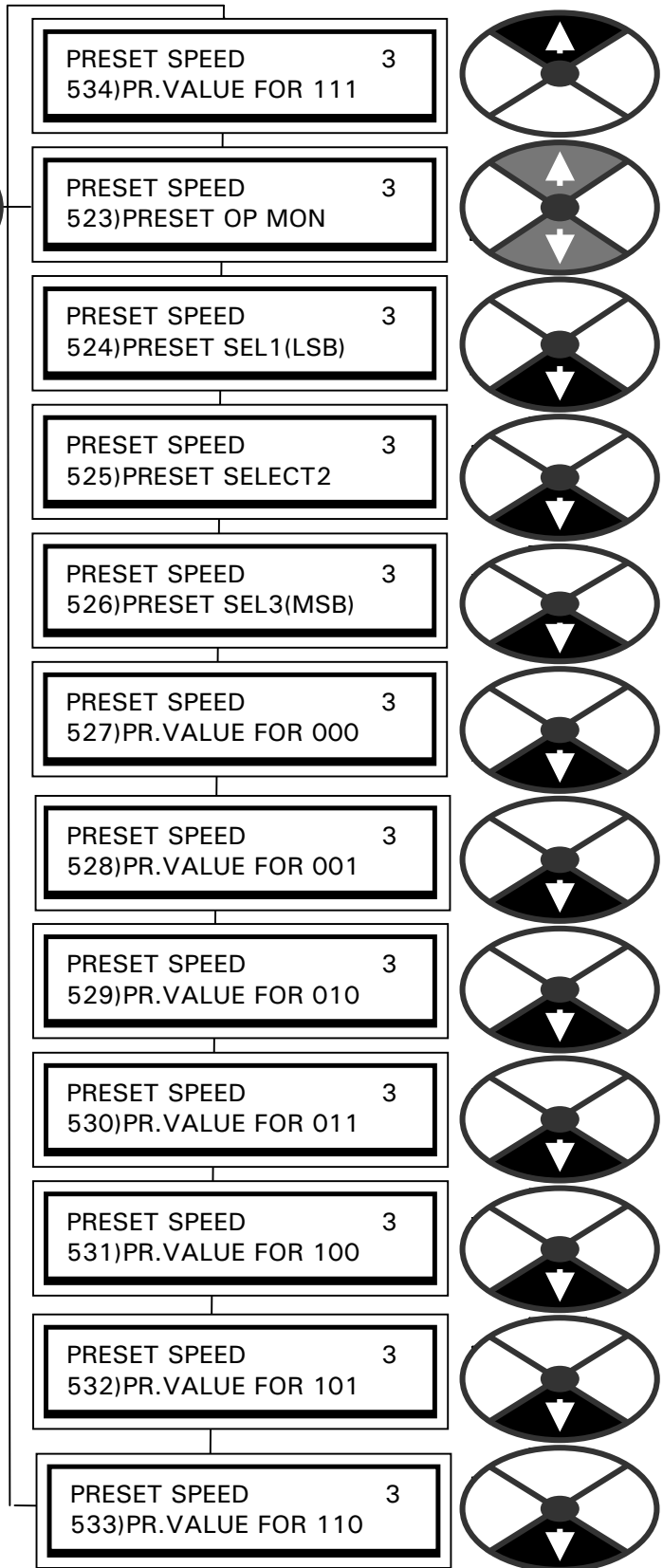

3.9.1 PRESET SPEED / Block diagram

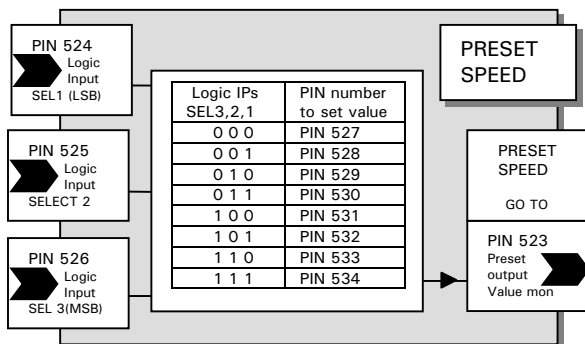

1) Ascending priority

Inputs 3,2,1	PIN number To set value	Actual value
0 0 0	PIN 527	0.00%
0 0 1	PIN 528	W%
0 1 0	PIN 529	X%
0 1 1	PIN 530	X%
1 0 0	PIN 531	Y%
1 0 1	PIN 532	Y%
1 1 0	PIN 533	Y%
1 1 1	PIN 534	Y%

Assuming that there are 3 output values (1 = W, 2 = X, 3 = Y) required and that logic select input 3 has the highest priority, followed by 2 and 1 in that order.

By entering the values for each PIN number as shown in the table the desired result is obtained.

2) Binary coded decimal

Inputs 3,2,1	PIN number OP value	Actual value
0 0 0	PIN 527	0.00%
0 0 1	PIN 528	10.00%
0 1 0	PIN 529	20.00%
0 1 1	PIN 530	30.00%
1 0 0	PIN 531	40.00%
1 0 1	PIN 532	50.00%
1 1 0	PIN 533	60.00%
1 1 1	PIN 534	70.00%

This will give 8 values up to 70.00% for the 8 BCD codes.

3) 4 digital inputs for 4 preset speeds.

Inputs 3,2,1	PIN number OP value	Actual value
0 0 0	PIN 527	25.00%
0 0 1	PIN 528	50.00%
0 1 0	PIN 529	75.00%
0 1 1	PIN 530	62.50%
1 0 0	PIN 531	100.00%
1 0 1	PIN 532	75.00%
1 1 0	PIN 533	87.50%
1 1 1	PIN 534	0.00%

Make the GOTO connection to the Value for low PIN on a digital input E.g. DIP1 on T14. Then connect the GOTO of DIP1 to the desired preset speed target PIN.

The DIP1 digital input will be the 25% input
The preset speed select1 input will be the 50% input
The preset speed select2 input will be the 75% input
The preset speed select3 input will be the 100% input

The intermediate combinations are shown here bolded with intermediate values for smoother transition, but may be set to other values as desired.

3.9.2 PRESET SPEED / Preset speed output monitor PIN 523

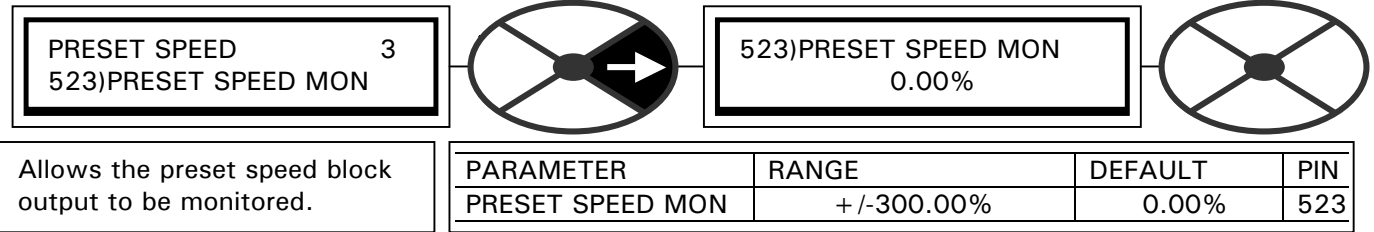

3.9.3 PRESET SPEED / Select bit inputs 1 lsb, 2, 3 msb PINs 524 / 525 / 526

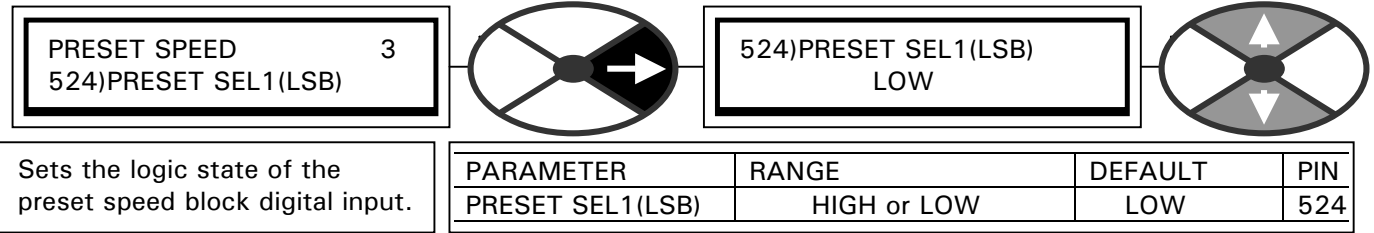

3.9.4 PRESET SPEED / OP value of 000 to 111 PINs 527 to 534

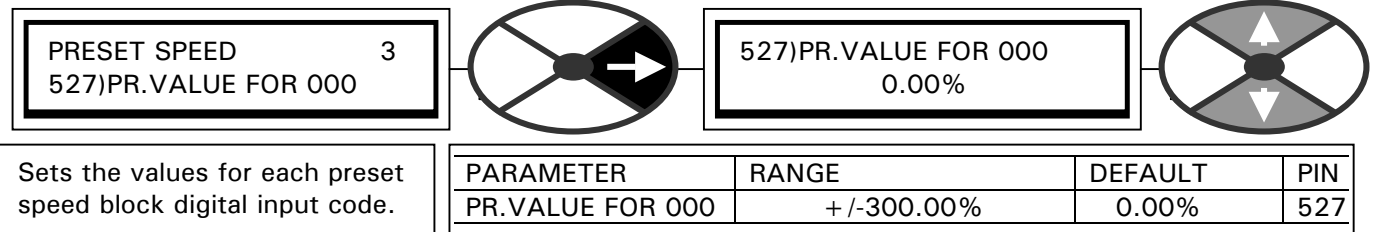

See 3.9.1 PRESET SPEED / Block diagram.

3.10 APPLICATION BLOCKS / MULTI-FUNCTION 1 to 8

PINs used 544 to 559

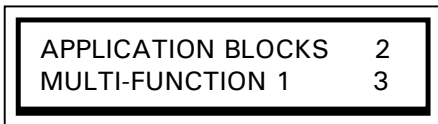

There are 8 identical independent MULTI FUNCTION blocks. They are identified by the suffix 1 to 8 in the menu windows.

Only number 1 is shown here.

They are used to perform simple signal processing on 1 or 2 signals.

Available functions are comparator, AND, OR, LOGIC INVERT, sign change, rectify and sample and hold. These blocks may also be used as JUMPERS to make connections.

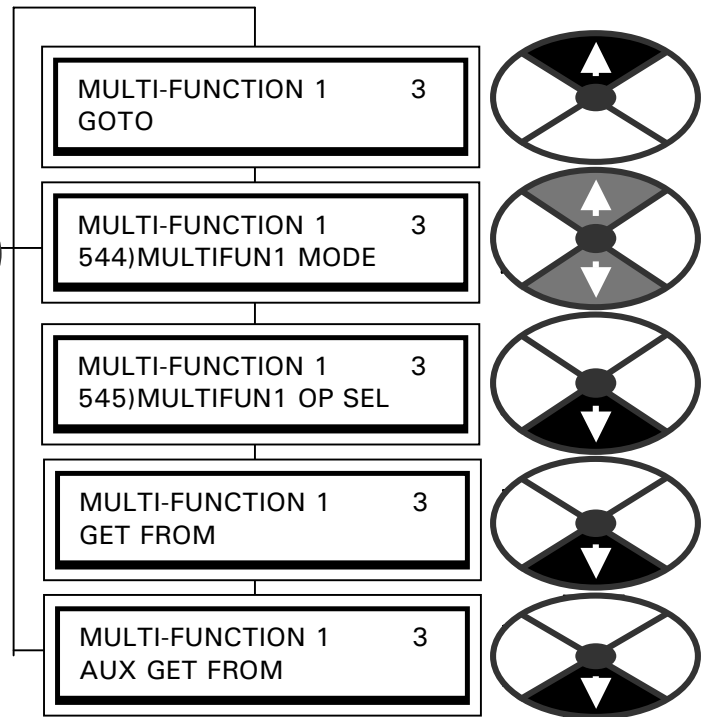

3.10.1 MULTI-FUNCTION / Block diagram

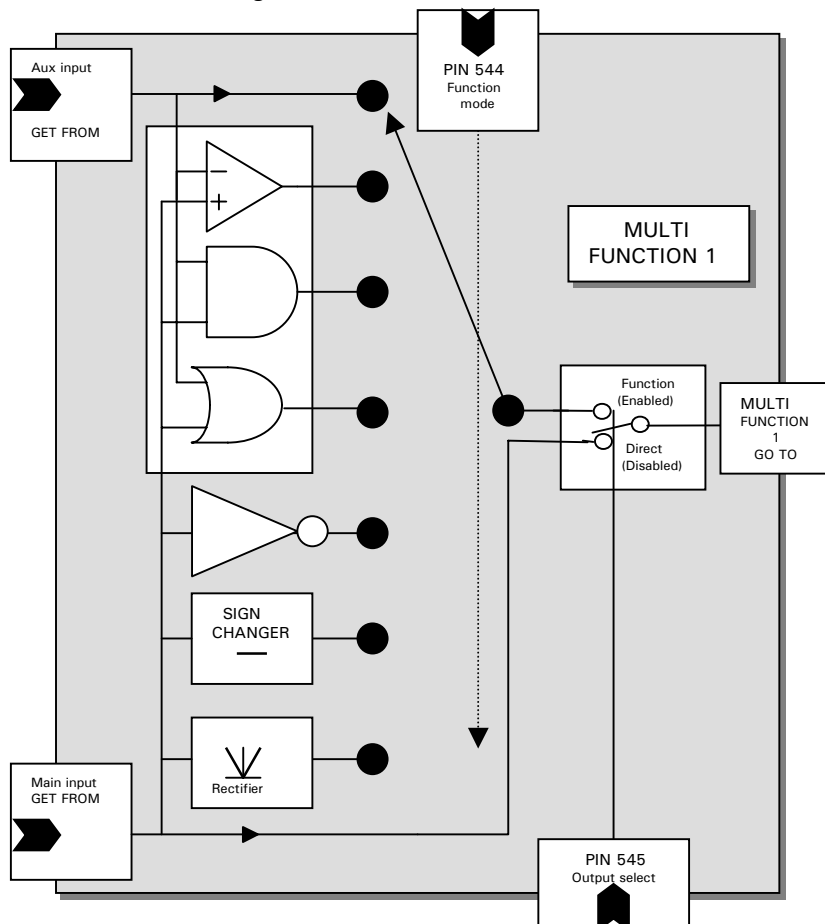

3.10.2 MULTI-FUNCTION 1 to 8 / Function mode PINs 544/6/8, 550/2/4/6/8

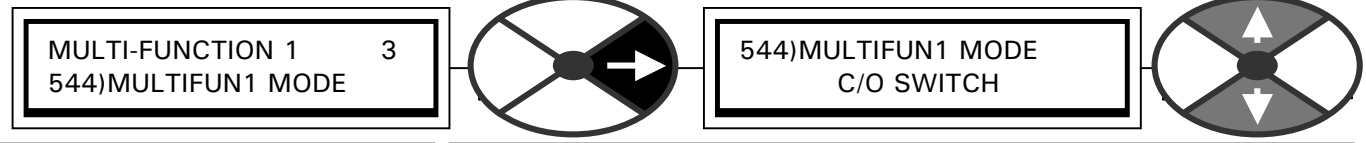

Select 1 of 7 transfer functions according the table below.

PARAMETER	RANGE	DEFAULT	PIN
MULTIFUN1 MODE	1 of 7 functions	C/O SWITCH	544

Note that a linear signal will be treated as a logical 0 by a logical function if its value is zero (any units), any other value including negative values will be treated as a logical 1.

Mode	Function	Function type	OP Description for MULTIFUN1 OP SEL ENABLED															
0	C/O SWITCH Or JUMPER	Linear or logical	The value at the aux input Use this for connections if JUMPERS are all used															
1	COMPARATOR	2 linear inputs, logical output	If MAIN > AUX output = 1 If MAIN < AUX output = 0															
2	AND GATE	2 logical inputs, logical output	<table border="1"> <thead> <tr> <th>MAIN</th> <th>AUX</th> <th>Output</th> </tr> </thead> <tbody> <tr><td>0</td><td>0</td><td>0</td></tr> <tr><td>0</td><td>1</td><td>0</td></tr> <tr><td>1</td><td>0</td><td>0</td></tr> <tr><td>1</td><td>1</td><td>1</td></tr> </tbody> </table>	MAIN	AUX	Output	0	0	0	0	1	0	1	0	0	1	1	1
MAIN	AUX	Output																
0	0	0																
0	1	0																
1	0	0																
1	1	1																
3	OR GATE	2 logical inputs, logical output	<table border="1"> <thead> <tr> <th>MAIN</th> <th>AUX</th> <th>Output</th> </tr> </thead> <tbody> <tr><td>0</td><td>0</td><td>0</td></tr> <tr><td>0</td><td>1</td><td>1</td></tr> <tr><td>1</td><td>0</td><td>1</td></tr> <tr><td>1</td><td>1</td><td>1</td></tr> </tbody> </table>	MAIN	AUX	Output	0	0	0	0	1	1	1	0	1	1	1	1
MAIN	AUX	Output																
0	0	0																
0	1	1																
1	0	1																
1	1	1																
4	INVERT	1 logical input, logical output	<table border="1"> <thead> <tr> <th>MAIN</th> <th>Output</th> </tr> </thead> <tbody> <tr><td>0</td><td>1</td></tr> <tr><td>1</td><td>0</td></tr> </tbody> </table> (The invert function output is also the EXOR (exclusive OR) of the MAIN and OP SELECT)	MAIN	Output	0	1	1	0									
MAIN	Output																	
0	1																	
1	0																	
5	SIGN CHANGER	1 linear input, linear output	Output = MAIN X (-1)															
6	RECTIFIER	1 linear input, linear output	Output = MAIN															

To create an Exclusive OR function easily. The invert mode OP is the EXOR of the MAIN, OP SELECT inputs

3.10.2.1 Sample and hold function

To perform a sample and hold simply set the AUX GET FROM source PIN to be the same as the output GOTO destination PIN and the MODE to 0. Then when the output select is disabled the output value will follow the main input. When the output select is enabled, the value pertaining at that time will be held.

See also 3.16.1.1 C/O switch used as sample and hold function.

3.10.3 MULTI-FUNCTION 1 to 8 / Output select 1 to 8 PIN 545/7/9, 551/3/5/7/9

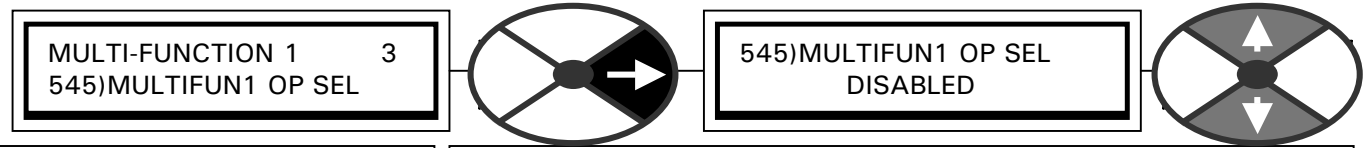

When disabled the main input flows directly to the output.

PARAMETER	RANGE	DEFAULT	PIN
MULTIFUN1 OP SEL	ENABLED or DISABLED	DISABLED	545

When enabled, 1 of 7 transfer functions selected by the logic mode switch is then output. When this PIN is used as a logic input with the main input in invert mode, the output is EXOR of the 2 inputs.

3.10.4 MULTI-FUNCTION 1 to 8 / Main input GET FROM 1 to 8

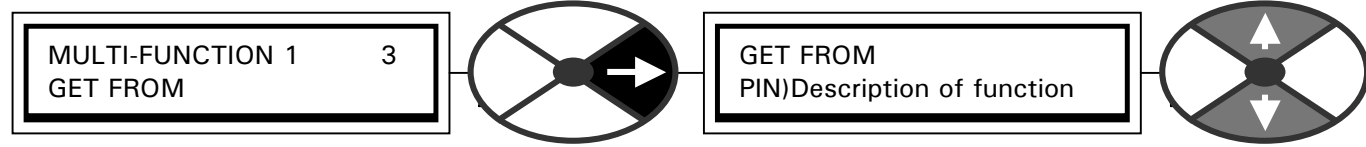

Sets the PIN for the main input signal source.

PARAMETER	RANGE	DEFAULT
GET FROM	000 to 720	400)Block disconnect

3.10.5 MULTI-FUNCTION 1 to 8 / Aux input GET FROM 1 to 8

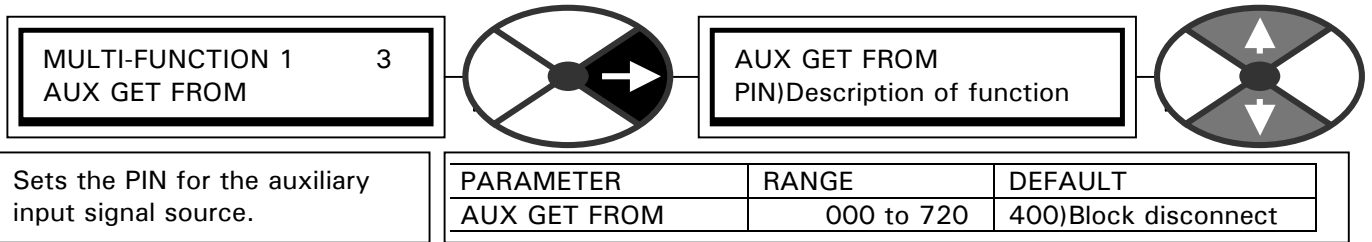

3.10.6 MULTI-FUNCTION 1 to 8 / GOTO 1 to 8

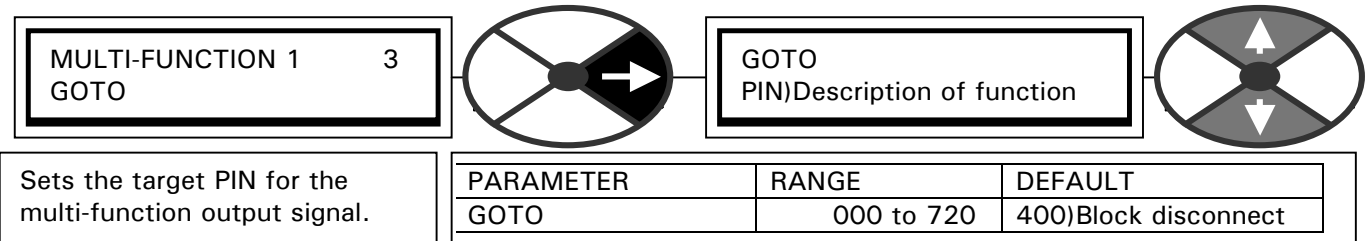

3.11 APPLICATION BLOCKS / LATCH

PINs used 560 to 566

APPLICATION BLOCKS	2
LATCH	3

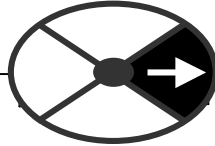

This block provides a standard D type latch function. The logic inputs are scanned at least once every 50mS hence the maximum operating frequency is 10Hz. See 3.1.1 Sample times.

3.11.1 LATCH / Block diagram

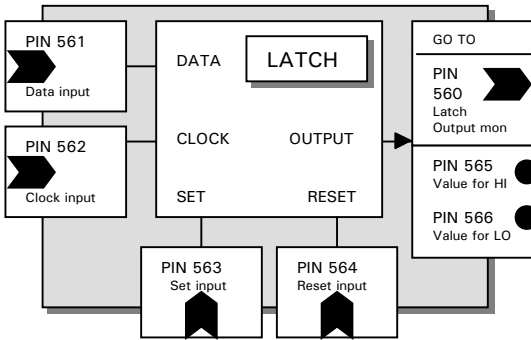

SET	RESET	CLOCK	DATA	OUTPUT
High	Low	Don't care	Don't care	Value for high
Low	High	Don't care	Don't care	Value for low
High	High	Don't care	Don't care	Value for high
Low	Low	+ VE EDGE	Low	Value for low
Low	Low	+ VE EDGE	High	Value for high

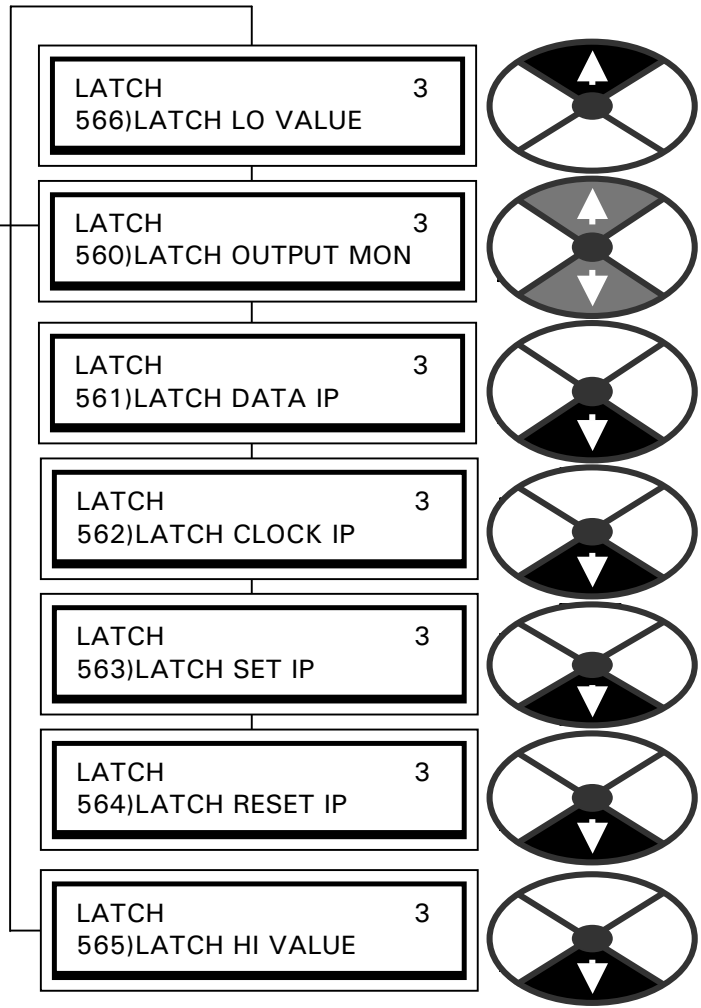

3.11.2 LATCH / Latch output monitor PIN 560

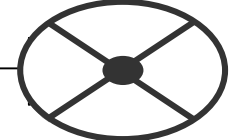
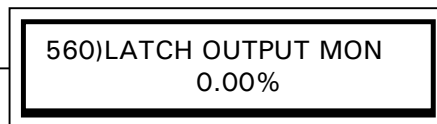
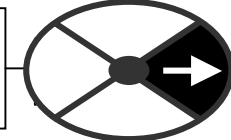

Shows the output value of the latch block.

PARAMETER	RANGE	DEFAULT	PIN
LATCH OUTPUT MON	+ /-300.00%	0.00%	560

3.11.3 LATCH / Latch data input PIN 561

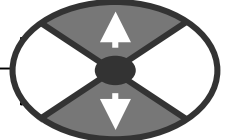
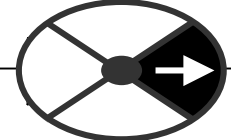

Sets logic level for the data input. Min dwell time 50mS.

PARAMETER	RANGE	DEFAULT	PIN
LATCH DATA IP	LOW or HIGH	LOW	561

If the clock level has changed from a low to a high since the last sample, then the logic level of the data input (high or low) is placed on the latch output stage giving an output value for high or low.

3.11.4 LATCH / Latch clock input PIN 562

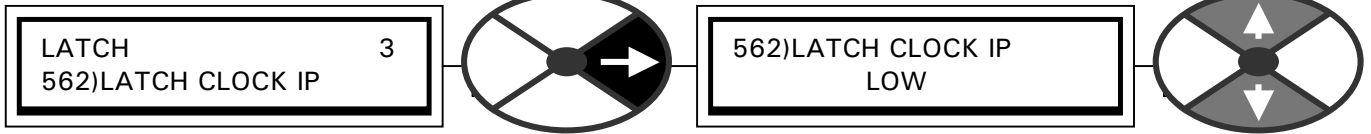

Sets logic level for the latch clock input.

PARAMETER	RANGE	DEFAULT	PIN
LATCH CLOCK IP	LOW or HIGH	LOW	562

If the clock level has changed from a low to a high since the last sample, then the logic level of the data input (high or low) is placed on the latch output stage giving an output value for high or low. See the truth table for a complete definition.

3.11.5 LATCH / Latch set input PIN 563

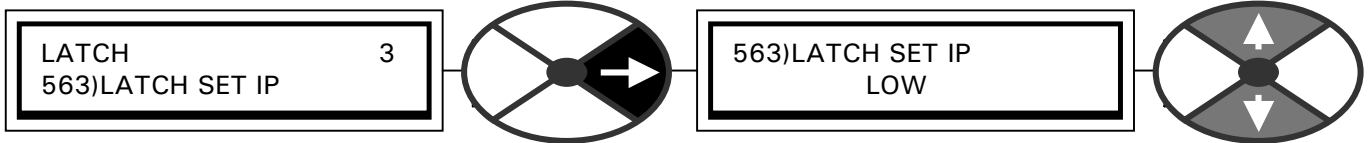

Sets logic level for the latch set input.

PARAMETER	RANGE	DEFAULT	PIN
LATCH SET IP	LOW or HIGH	LOW	563

See the truth table for a complete definition.

3.11.6 LATCH / Latch reset input PIN 564

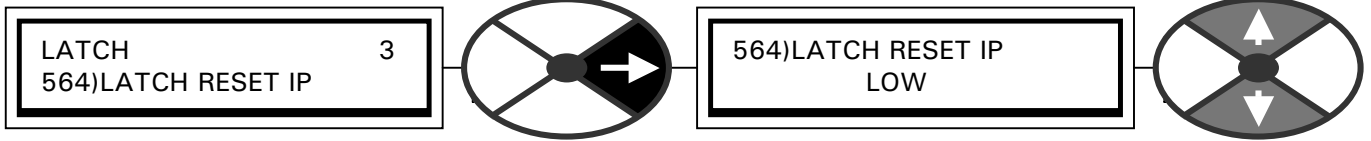

Sets logic level for the latch reset input.

PARAMETER	RANGE	DEFAULT	PIN
LATCH RESET IP	LOW or HIGH	LOW	564

See the truth table for a complete definition.

3.11.7 LATCH / Latch output value for HI/LOW PINs 565 / 566

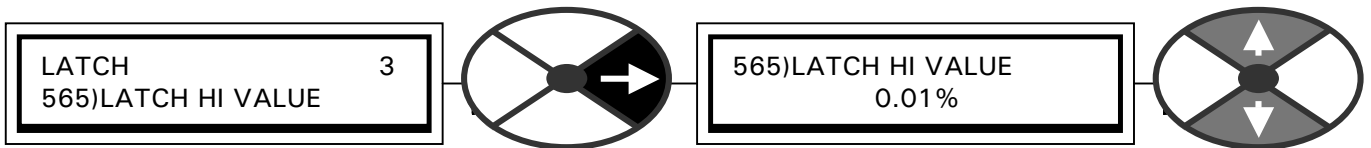

Sets the output value for the high result

PARAMETER	RANGE	DEFAULT	PIN
LATCH HI VALUE	+/-300.00%	0.01%	565

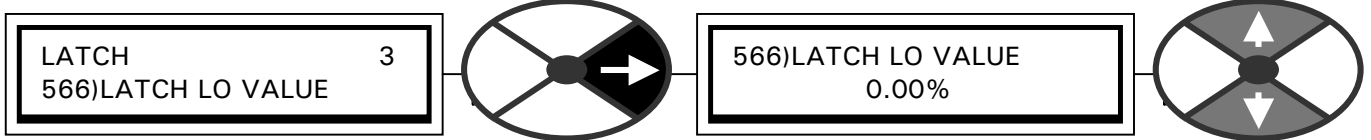

Sets the output value for the low result

PARAMETER	RANGE	DEFAULT	PIN
LATCH LO VALUE	+/-300.00%	0.00%	566

3.12 APPLICATION BLOCKS / FILTER 1, 2

PINs used 568/9 and 573/4
There are 2 identical filter blocks

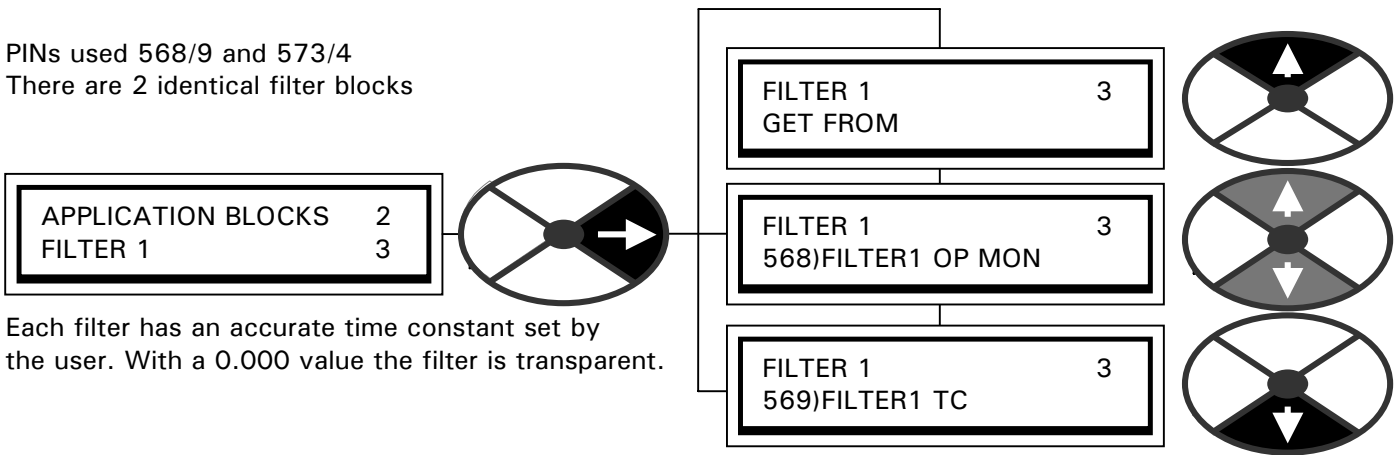

Each filter has an accurate time constant set by the user. With a 0.000 value the filter is transparent.

There is also a simple low pass filter in the hidden PIN list. Input is PIN 705, and output is PIN 706

3.12.1 FILTER / Block diagram

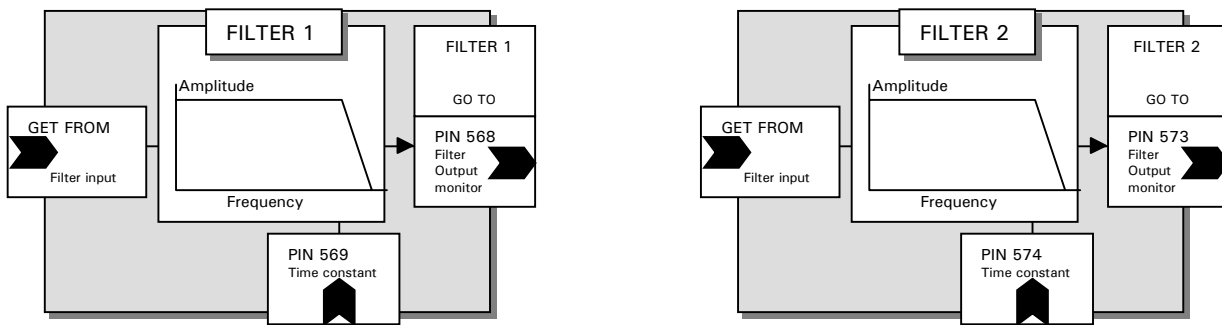

The filters are useful for eliminating mechanical resonance effects from the control system closed loop.

3.12.2 FILTER 1, 2 / Filter output monitor PIN 568 / 573

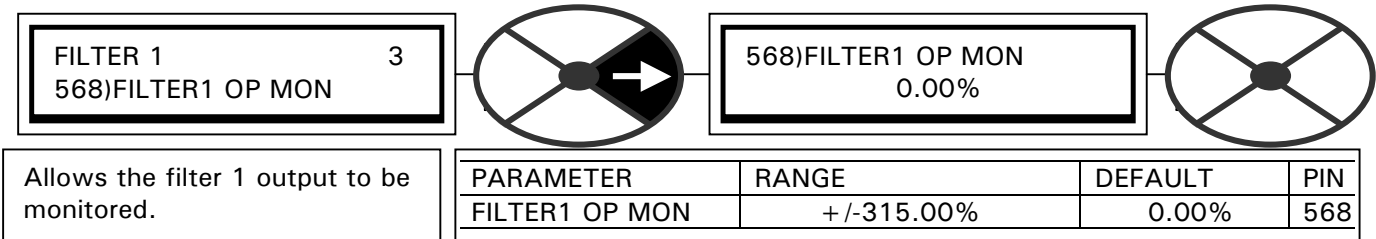

Allows the filter 1 output to be monitored.

3.12.3 FILTER 1, 2 / Filter time constant PIN 569 / 574

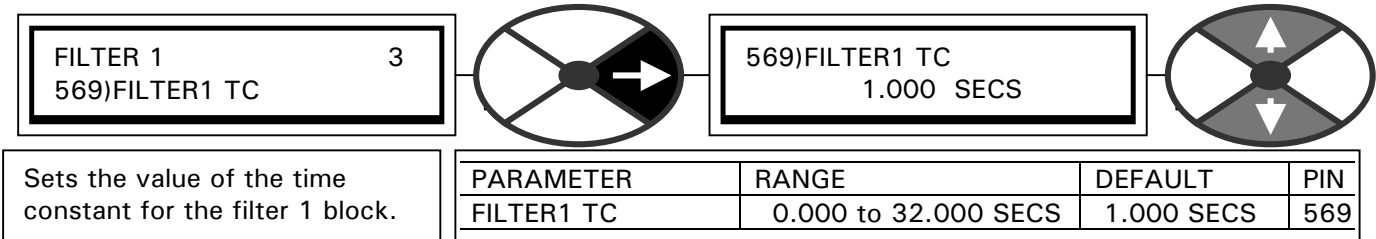

Sets the value of the time constant for the filter 1 block.

For filter time constants in excess of 32.000 seconds, the filters may be cascaded.

3.12.4 FIXED LOW PASS FILTER

There is a simple low pass filter function with a cut off frequency of approximately 10 Hz.

It may be useful for smoothing linear signals or eliminating resonances.

The filter does not have any adjustments hence the PIN numbers are hidden.

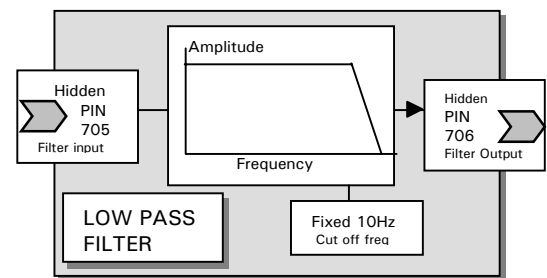

To use the filter connect the input using a GOTO window from another block, and connect the output using a GETFROM from the destination block. Alternatively use JUMPERS to make the connections.

3.13 APPLICATION BLOCKS / BATCH COUNTER

PINs used 578 to 582

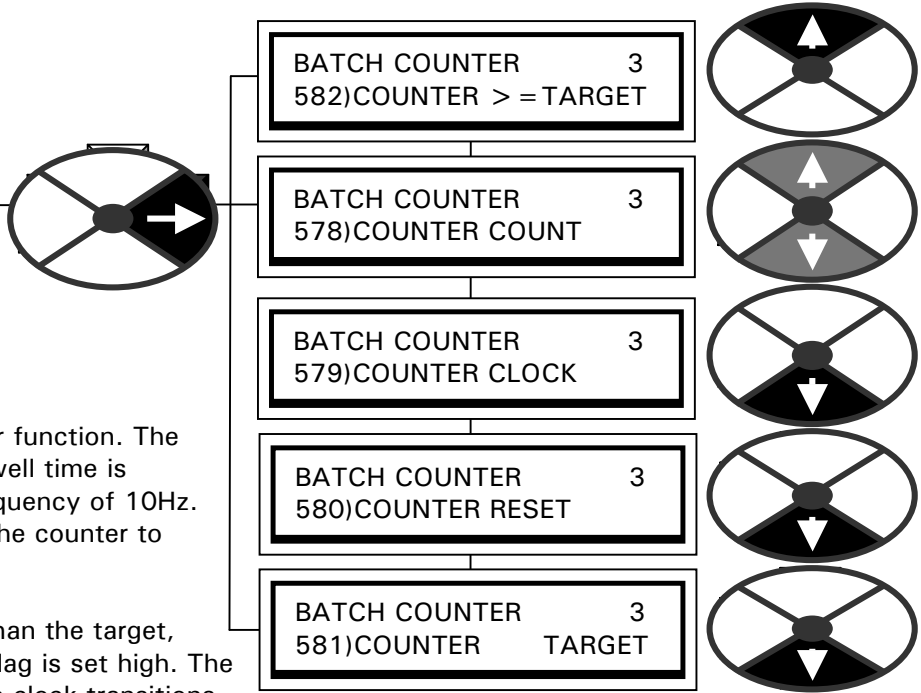

This block provides a batch counter function. The minimum low or high logic input dwell time is 50mS giving a maximum count frequency of 10Hz. A positive clock transition causes the counter to count up.

If the count is equal to or greater than the target, then 582)COUNTER >= TARGET flag is set high. The counter continues counting positive clock transitions unless the reset input is high or the counter reaches 32000. This feature is useful if the counter is used to signal intermediate points within a total batch. The count target may be changed without interfering with the counting process.

The reset input resets the counter to zero.

3.13.1 BATCH COUNTER / Block diagram

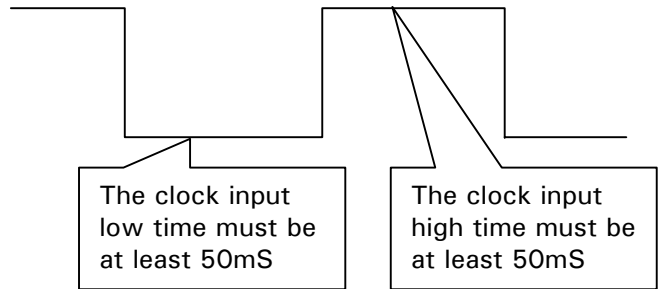
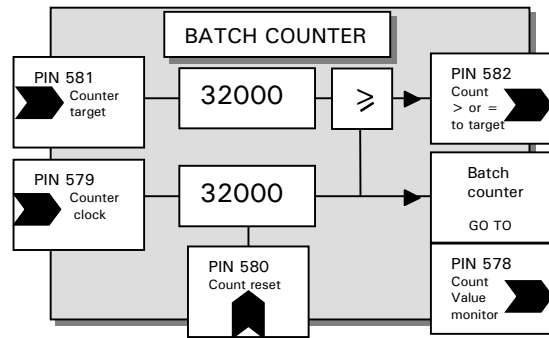

See 3.1.1 Sample times.

3.13.2 BATCH COUNTER / Counter count monitor PIN 578

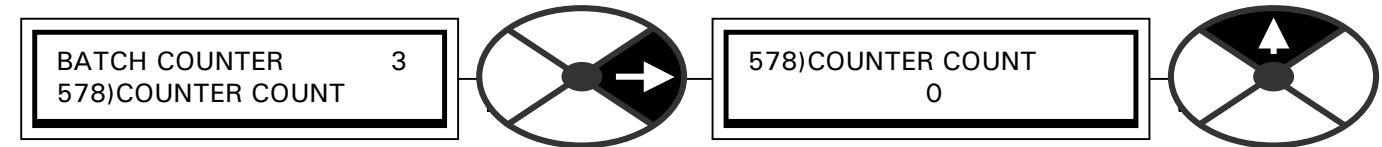

Allows the batch counter value to be monitored.

PARAMETER	RANGE	PIN
COUNTER COUNT	0 to 32000	578

Note. This value is the output of the block GOTO connection.

This window has a branch hopping facility to 3.13.6 BATCH COUNTER / Count equal or greater than target flag PIN 582.

3.13.3 BATCH COUNTER / Clock input PIN 579

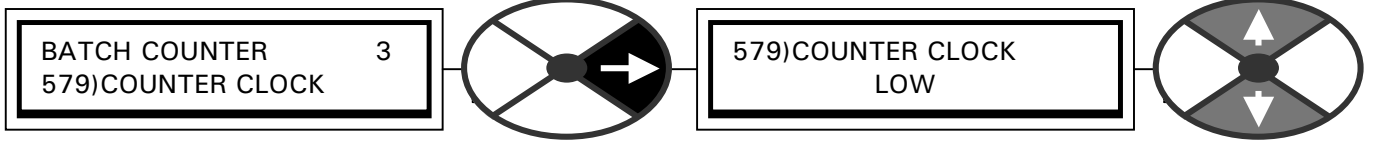

Sets the clock input logic level for the batch counter.

PARAMETER	RANGE	DEFAULT	PIN
COUNTER CLOCK	LOW or HIGH	LOW	579

The counter will increment on a positive clock transition.

3.13.4 BATCH COUNTER / Reset input PIN 580

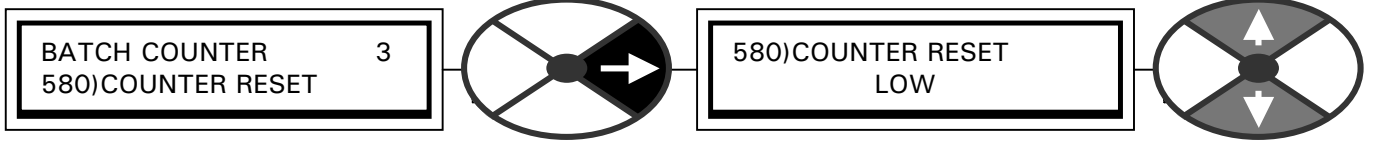

Sets the reset input logic level for the batch counter.

PARAMETER	RANGE	DEFAULT	PIN
COUNTER RESET	LOW or HIGH	LOW	580

The counter is held reset while the reset input is high.

3.13.5 BATCH COUNTER / Counter target number PIN 581

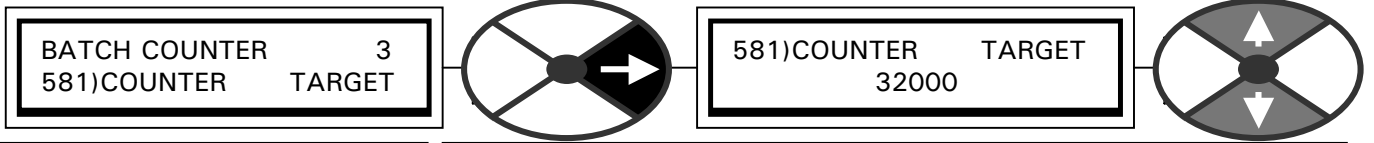

Sets the target number for the batch counter.

PARAMETER	RANGE	DEFAULT	PIN
COUNTER TARGET	0 to 32000	32000	581

When the batch counter value equals or exceeds the target value this output goes high. Changing the counter target does not interfere with the counting process.

3.13.6 BATCH COUNTER / Count equal or greater than target flag PIN 582

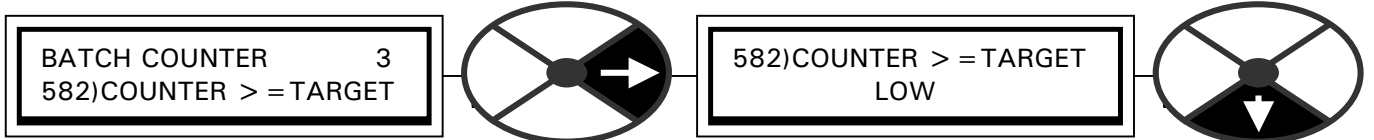

Allows the equal or greater output flag to be monitored.

PARAMETER	RANGE	PIN
COUNTER >= TARGET	LOW or HIGH	582

When the batch counter value equals or exceeds the target value the equal output goes high.

Note. By using a jumper to connect this flag to 580)COUNTER RESET, it is possible to make the counter roll over at the counter target number and continue counting from 0 again.

Branch hopping facility to 3.13.2 BATCH COUNTER / Counter count monitor PIN 578

3.14 APPLICATION BLOCKS / INTERVAL TIMER

PINs used 584 to 586

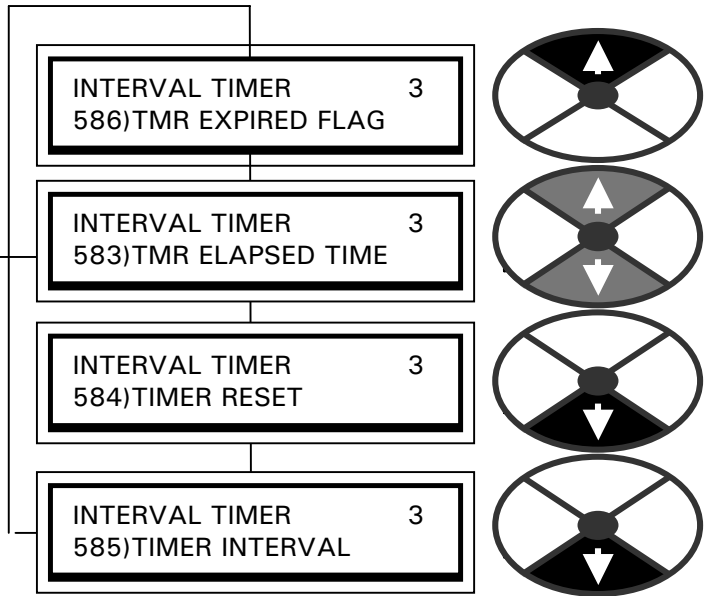
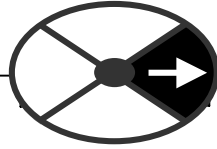
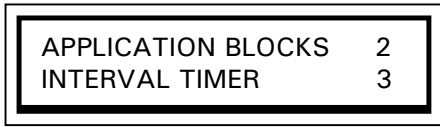

3.14.1 INTERVAL TIMER / Block diagram

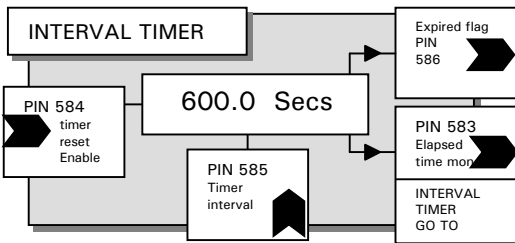

The INTERVAL TIMER may be used to control event sequencing in systems applications.

E. g. If a motion control sequence must wait before starting or a relay changeover delayed.

3.14.2 INTERVAL TIMER / Time elapsed monitor PIN 583

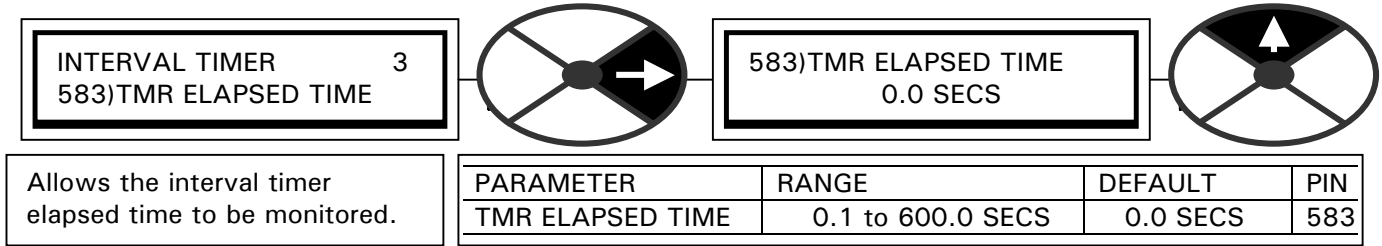

Note. This value is the output of the block GOTO connection. When the total interval time has elapsed the block output goes high until the next disable/enable sequence. This window has a branch hopping facility to 3.14.5 INTERVAL TIMER / Timer expired flag PIN 586.

3.14.3 INTERVAL TIMER / Timer reset enable PIN 584

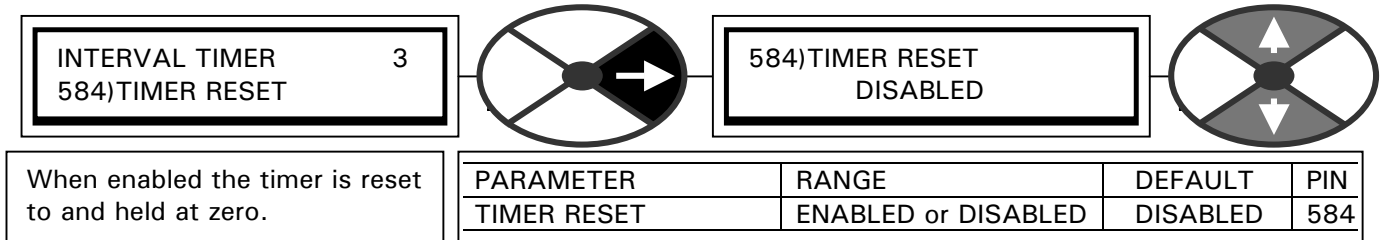

The timer commences timing when disabled. The timer is reset if the input is enabled prior to timing out.

3.14.4 INTERVAL TIMER / Time interval setting PIN 585

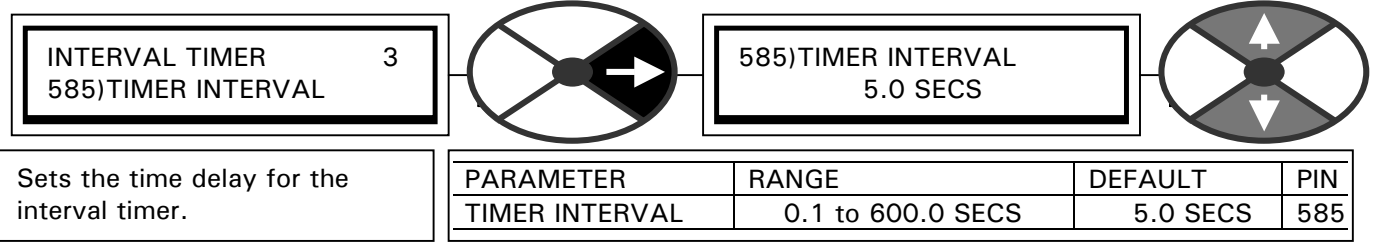

Sets the time delay for the interval timer.

When the time delay has elapsed the block output goes high. It stays high until the next disable input.

3.14.5 INTERVAL TIMER / Timer expired flag PIN 586

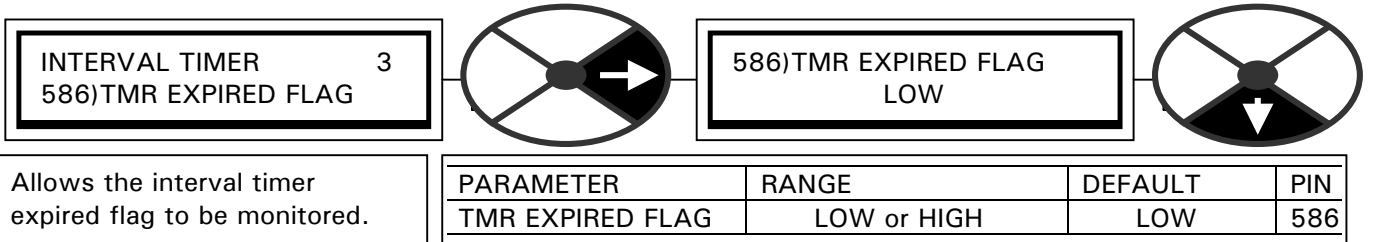

Allows the interval timer expired flag to be monitored.

This window has a branch hopping facility to 3.14.2 INTERVAL TIMER / Time elapsed monitor PIN 583.

Note. By connecting this flag to 584)TIMER RESET using a jumper, it is possible to make the timer roll over and continue timing from 0 again.

3.15 APPLICATION BLOCKS / COMPARATOR 1 to 4

Pins 588 to 603

There are 4 identical comparators each with adjustable hysteresis and a window mode option. This description applies to all 4.

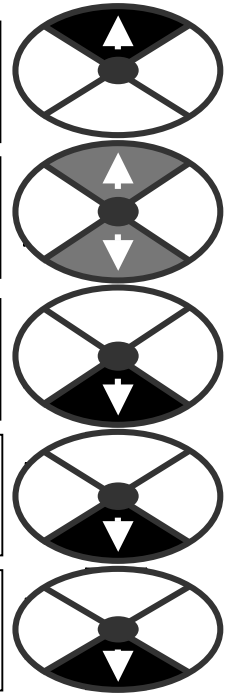
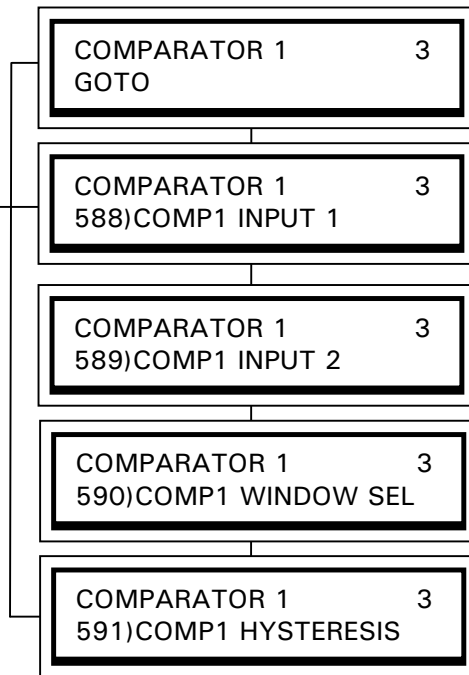
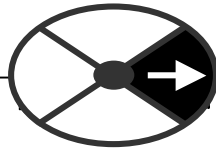
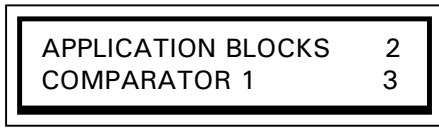

3.15.1 COMPARATOR 1 / Block diagram

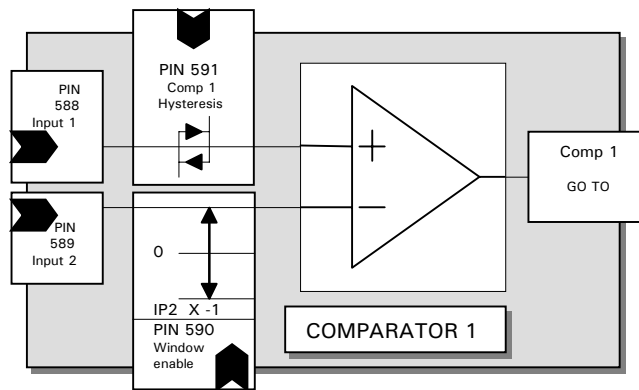

With the window mode disabled, the block functions as a comparator with input 1 on the positive input and input 2 on the negative input.

The hysteresis level is applied above and below the value of input 1. The hysteresis range is 0 - 10.00%.

If the window mode is enabled, then the value on input 2 creates a symmetrical window around zero. If the value on input 1 lies within the window then the comparator output is high. If hysteresis is used in the window mode it is applied at each boundary.

3.15.2 COMPARATOR 1/2/3/4 / Input 1 PIN 588/592/596/600

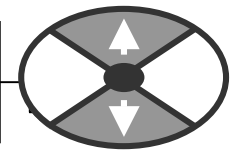
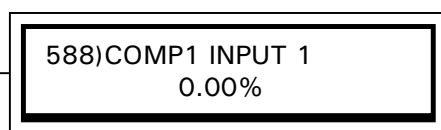
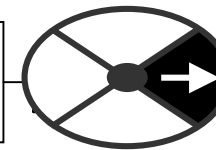
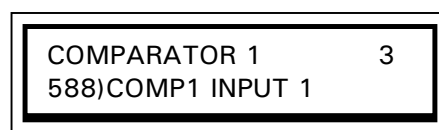

Sets the level of input 1 (+ve) of the comparator 1.

PARAMETER	RANGE	DEFAULT	PIN
COMP1 INPUT 1	+/- 300.00%	0.00%	588

The output is high for input 1 > input 2 (algebraic). The output is low for input 1 = < input 2 (algebraic).

3.15.3 COMPARATOR 1/2/3/4 / Input 2 PIN 589/593/597/601

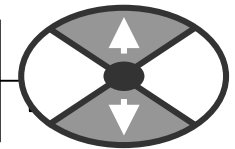
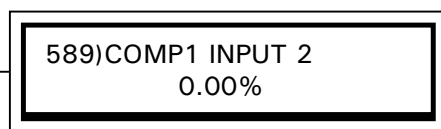
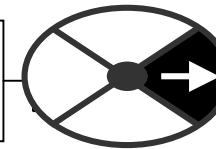
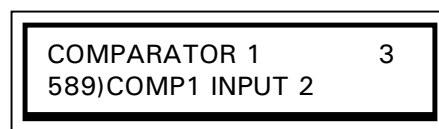

Sets the level of input 2 (-ve) of the comparator 1.

PARAMETER	RANGE	DEFAULT	PIN
COMP1 INPUT 2	+/- 300.00%	0.00%	589

The output is high for input 1 > input 2 (algebraic). The output is low for input 1 = < input 2 (algebraic).

3.15.4 COMPARATOR 1/2/3/4 / Window mode select PIN 590/594/598/602

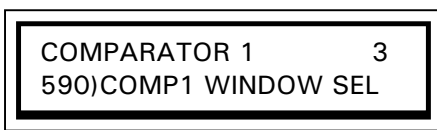

Enables the window comparator mode.

PARAMETER	RANGE	DEFAULT	PIN
COMP1 WINDOW SEL	ENABLED or DISABLED	DISABLED	590

The output is **low** for input 1 > or = < the window amplitude created by input 2 (algebraic).
 The window is created symmetrically around 0.00% and has a range of +/- input 2.
 If hysteresis is applied it operates at each boundary of the window.

3.15.5 COMPARATOR 1/2/3/4 / Hysteresis PIN 591/595/599/603

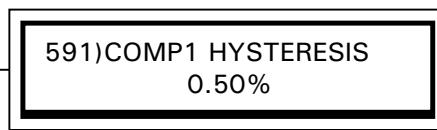
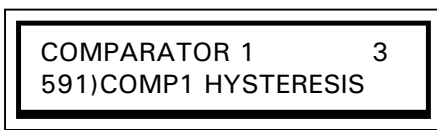

Sets the level of hysteresis applied to input 1 (-ve).

PARAMETER	RANGE	DEFAULT	PIN
COMP1 HYSTERESIS	0 to 10.00%	0.50%	591

E. g. A value of 1.00% requires input 1 to exceed input 2 by more than 1.00% for a high output and to fall below input 2 by 1.00% or more to go low.

3.15.6 COMPARATOR 1/2/3/4 / Comparator GOTO

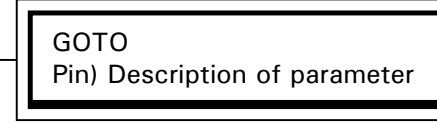
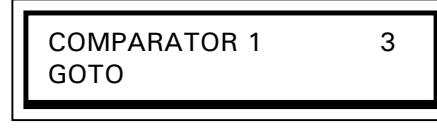

Sets the PIN for the GOTO connection target parameter.

PARAMETER	RANGE	DEFAULT
GOTO	2 to 720	400)Block disconnect

Note. To activate the block the GOTO must be connected to a PIN other than 400)Block disconnect.

3.16 APPLICATION BLOCKS / C/O SWITCH 1 to 4

Pins 604 to 615

There are 4 identical changeover switches each with 2 inputs and 1 output. This description applies to all 4.

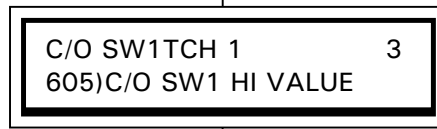
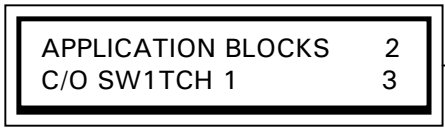

3.16.1 C/O SWITCH / Block diagram

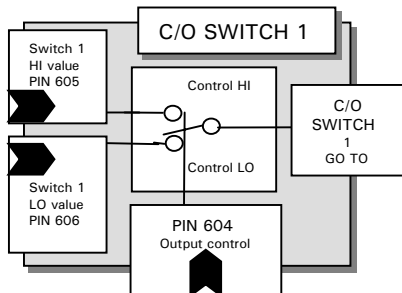

3.16.1.1 C/O switch used as sample and hold function

Note. A sample and hold function can be implemented by connecting the output to 606)C/O SW1 LO VALUE. The value on 605)C/O SW1 HI VALUE will be transferred to 606)C/O SW1 LO VALUE when 604)C/O SW1 CONTROL is HIGH. It will be held at the value pertaining when the control goes LOW.

3.16.2 C/O SWITCH 1/2/3/4 / Control PIN 604/607/610/613

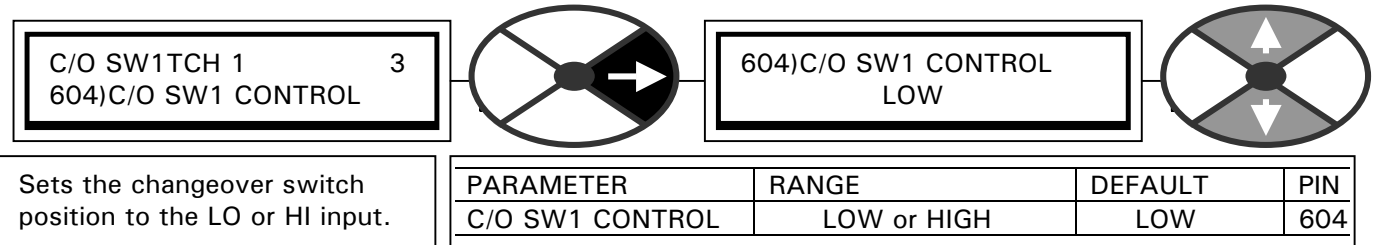

3.16.3 C/O SWITCH 1/2/3/4 / Inputs HI/LO PIN 605/608/611/614 / 606/609/612/615

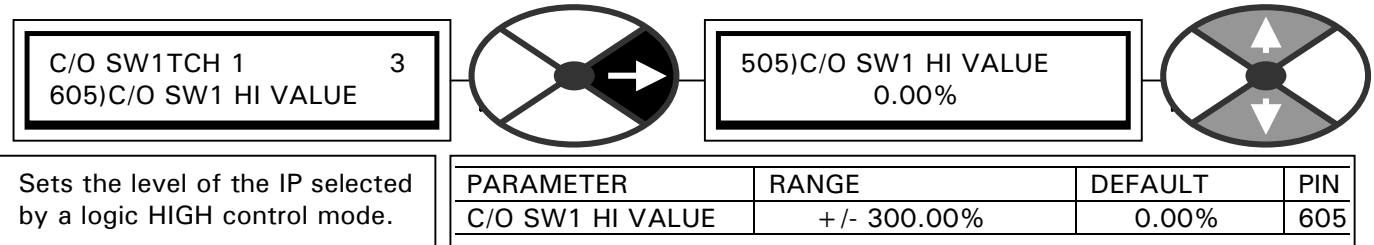

Note. 606)C/O SW1 LO VALUE Sets the level of the IP selected by a logic LOW control mode.

3.16.4 C/O SWITCH 1/2/3/4 / C/O switch GOTO

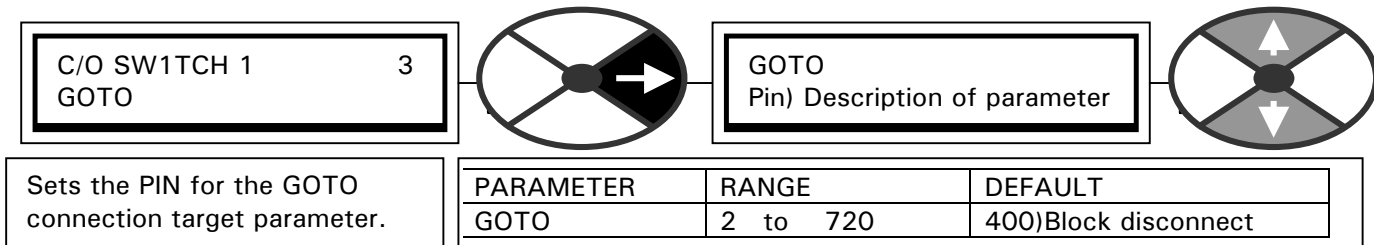

Note. To activate the block the GOTO must be connected to a PIN other than 400)Block disconnect.

4 PIN table for application blocks 401 - 680

	Paragraph number	Menu / Description	Range	Default Values	PIN
		Block disconnect			400
	3.2.2	SUMMER 1 / Total output value monitor PIN 401	+/-200.00%	0.00%	401
	3.2.3	SUMMER 1 / Sign 1 PIN 402	0 - 1	Non-invert	402
	3.2.4	SUMMER 1 / Sign 2 PIN 403	0 - 1	Non-invert	403
	3.2.5	SUMMER 1 / Ratio 1 PIN 404	+/-3.0000	1.0000	404
	3.2.6	SUMMER 1 / Ratio 2 PIN 405	+/-3.0000	1.0000	405
	3.2.7	SUMMER 1 / Divider 1 PIN 406	+/-3.0000	1.0000	406
	3.2.8	SUMMER 1 / Divider 2 PIN 407	+/-3.0000	1.0000	407
	3.2.9	SUMMER 1 / Input 1 PIN 408	+/-300.00%	0.00%	408
	3.2.10	SUMMER 1 / Input 2 PIN 409	+/-300.00%	0.00%	409
	3.2.11	SUMMER 1 / Input 3 PIN 410	+/-300.00%	0.00%	410
	3.2.12	SUMMER 1 / Deadband PIN 411	0 - 100.00%	0.00%	411
	3.2.13	SUMMER 1 / Output sign inverter PIN 412	0 - 1	Non-invert	412
	3.2.14	SUMMER 1 / Symmetrical clamp PIN 413	0 - 200.00%	105.00%	413
					414
	3.2.2	SUMMER 2 / Total output value monitor PIN 415	+/-200.00%	0.00%	415
	3.2.3	SUMMER 2 / Sign 1 PIN 416	0 - 1	Non-invert	416
	3.2.4	SUMMER 2 / Sign 2 PIN 417	0 - 1	Non-invert	417
	3.2.5	SUMMER 2 / Ratio 1 PIN 418	+/-3.0000	1.0000	418
	3.2.6	SUMMER 2 / Ratio 2 PIN 419	+/-3.0000	1.0000	419
	3.2.7	SUMMER 2 / Divider 1 PIN 420	+/-3.0000	1.0000	420
	3.2.8	SUMMER 2 / Divider 2 PIN 421	+/-3.0000	1.0000	421
	3.2.9	SUMMER 2 / Input 1 PIN 422	+/-300.00%	0.00%	422
	3.2.10	SUMMER 2 / Input 2 PIN 423	+/-300.00%	0.00%	423
	3.2.11	SUMMER 2 / Input 3 PIN 424	+/-300.00%	0.00%	424
	3.2.12	SUMMER 2 / Deadband PIN 425	0 - 100.00%	0.00%	425
	3.2.13	SUMMER 2 / Output sign inverter PIN 426	0 - 1	Non-invert	426
	3.2.14	SUMMER 2 / Symmetrical clamp PIN 427	0 - 200.00%	105.00%	427
					428
	3.3.2	PID 1 / Pid1 output value monitor PIN 429	+/-300.00%	0.00%	429
	3.3.3	PID 1 / Pid1 IP1 value PIN 430	+/-300.00%	0.00%	430
	3.3.4	PID 1 / Pid1 IP1 ratio PIN 431	+/-3.0000	1.0000	431
	3.3.5	PID 1 / Pid1 IP1 divider PIN 432	+/-3.0000	1.0000	432
	3.3.6	PID 1 / Pid1 IP2 value PIN 433	+/-300.00%	0.00%	433
	3.3.7	PID 1 / Pid1 IP2 ratio PIN 434	+/-3.0000	1.0000	434
	3.3.8	PID 1 / Pid1 IP2 divider PIN 435	+/-3.0000	1.0000	435
	3.3.9	PID 1 / Pid1 proportional gain PIN 436	0.0 - 100.0	1.0	436
	3.3.10	PID 1 / Pid1 integrator time constant PIN 437	.01-100.00 s	5.00 secs	437
	3.3.11	PID 1 / Pid1 derivative time constant PIN 438	0 - 10.000s	0.000 secs	438
	3.3.12	PID 1 / Pid1 derivative filter time constant PIN 439	0 - 10.000s	0.100 secs	439
	3.3.13	PID 1 / Pid1 integrator preset enable PIN 440	0 - 1	Disabled	440
	3.3.14	PID 1 / Pid1 integrator preset value PIN 441	+/-300.00%	0.00%	441
	3.3.15	PID 1 / Pid1 reset enable PIN 442	0 - 1	Disabled	442
	3.3.16	PID 1 / Pid1 positive clamp level PIN 443	0 - 105.00%	100.00%	443
	3.3.17	PID 1 / Pid1 negative clamp level PIN 444	0 - -105.00%	-100.00%	444
	3.3.18	PID 1 / Pid1 output % trim PIN 445	+/-3.0000	0.2000	445
	3.3.19	PID 1 / Pid1 Profile mode select PIN 446	1 of 5 modes	0 (constant)	446
	3.3.20	PID 1 / Pid1 Minimum proportional gain % PIN 447	0 - 100.00%	20.00%	447
	3.3.21	PID 1 / Pid1 Profile X axis minimum PIN 448	0 - 100.00%	0.00%	448
	3.3.23	PID 1 / Pid1 Profiled proportional gain output PIN 449	0 - 100.0	0.0	449
	3.3.24	PID 1 / Pid1 clamp flag monitor PIN 450	0 - 1	Low	450
	3.3.25	PID 1 / Pid1 error value monitor PIN 451	+/-105.00%	0.00%	451
	3.3.2	PID 2 / Pid2 output value monitor PIN 452	+/-300.00%	0.00%	452
	3.3.3	PID 2 / Pid2 IP1 value PIN 453	+/-300.00%	0.00%	453
	3.3.4	PID 2 / Pid2 IP1 ratio PIN 454	+/-3.0000	1.0000	454
	3.3.5	PID 2 / Pid2 IP1 divider PIN 455	+/-3.0000	1.0000	455
	3.3.6	PID 2 / Pid2 IP2 value PIN 456	+/-300.00%	0.00%	456
	3.3.7	PID 2 / Pid2 IP2 ratio PIN 457	+/-3.0000	1.0000	457
	3.3.8	PID 2 / Pid2 IP2 divider PIN 458	+/-3.0000	1.0000	458
	3.3.9	PID 2 / Pid2 proportional gain PIN 459	0.0 - 100.00	1.0	459
	3.3.10	PID 2 / Pid2 integrator time constant PIN 460	.01-100.00 s	5.00 secs	460

Paragraph number	Menu / Description	Range	Default Values	PIN
3.3.11	PID 2 / Pid2 derivative time constant PIN 461	0 -10.000s	0.000 secs	461
3.3.12	PID 2 / Pid2 derivative filter time constant PIN 462	0 -10.000s	0.100 secs	462
3.3.13	PID 2 / Pid2 integrator preset enable PIN 463	0 - 1	Disabled	463
3.3.14	PID 2 / Pid2 integrator preset value PIN 464	+/-300.00%	0.00%	464
3.3.15	PID 2 / Pid2 reset enable PIN 465	0 - 1	Disabled	465
3.3.16	PID 2 / Pid2 positive clamp level PIN 466	0 - 105.00%	100.00%	466
3.3.17	PID 2 / Pid2 negative clamp level PIN 467	0 - -105.00%	-100.00%	467
3.3.18	PID 2 / Pid2 output % trim PIN 468	+/-3.0000	0.2000	468
3.3.19	PID 2 / Pid2 Profile mode select PIN 469	1 of 5 modes	0 (constant)	469
3.3.20	PID 2 / Pid2 Minimum proportional gain % PIN 470	0 - 100.00%	20.00%	470
3.3.21	PID 2 / Pid2 Profile X axis minimum PIN 471	0 - 100.00%	0.00%	471
3.3.23	PID 2 / Pid2 Profiled proportional gain output PIN 472	0 - 100.0	0.0	472
3.3.24	PID 2 / Pid2 clamp flag monitor PIN 473	0 - 1	Low	473
3.3.25	PID 2 / Pid2 error value monitor PIN 474	+/-105.00%	0.00%	474
3.4.2	PARAMETER PROFILER / Profile Y output monitor PIN 475	+/-300.00%	0.00%	475
3.4.3	PARAMETER PROFILER / Profiler mode PIN 476	1 of 5 modes	0 (constant)	476
3.4.4	PARAMETER PROFILER / Profile Y at Xmin PIN 477	+/-300.00%	0.00%	477
3.4.5	PARAMETER PROFILER / Profile Y at Xmax PIN 478	+/-300.00%	100.00%	478
3.4.6	PARAMETER PROFILER / Profile X axis minimum PIN 479	+/-300.00%	0.00%	479
3.4.7	PARAMETER PROFILER / Profile X axis maximum PIN 480	+/-300.00%	100.00%	480
3.4.8	PARAMETER PROFILER / Profile X axis rectify PIN 481	0 - 1	Enabled	481
				482
3.5.2	REEL DIAMETER CALC / Diameter output monitor PIN 483	0 - 100.00%	0.00%	483
3.5.3	REEL DIAMETER CALC / Web speed input PIN 484	+/-105.00%	0.00%	484
3.5.4	REEL DIAMETER CALC / Reel speed input PIN 485	+/-105.00%	0.00%	485
3.5.5	REEL DIAMETER CALC / Minimum diameter input PIN 486	0 - 100.00%	10.00%	486
3.5.6	REEL DIAMETER CALC / Diameter calculation min speed PIN 487	+/-105.00%	5.00%	487
3.5.7	REEL DIAMETER CALC / Diameter hold enable PIN 488	0 - 1	Disabled	488
3.5.8	REEL DIAMETER CALC / Diameter filter time constant PIN 489	0.1 - 200.0 s	5.00 secs	489
3.5.9	REEL DIAMETER CALC / Diameter preset enable PIN 490	0 - 1	Disabled	490
3.5.10	REEL DIAMETER CALC / Diameter preset value PIN 491	0 - 100.00%	10.00%	491
3.5.11	REEL DIAMETER CALC / Diameter web break threshold PIN 492	0 - 100.00%	7.50%	492
3.5.12	REEL DIAMETER CALC / Diameter memory boot up PIN 493	0 - 1	Disabled	493
3.6.2	TAPER TENSION CALC / Total tension output monitor PIN 494	+/-100.00%	0.00%	494
3.6.3	TAPER TENSION CALC / Tension reference PIN 495	0 - 100.00%	0.00%	495
3.6.4	TAPER TENSION CALC / Taper strength input PIN 496	+/-100.00%	0.00%	496
3.6.5	TAPER TENSION CALC / Hyperbolic taper enable PIN 497	0 - 1	Disabled	497
3.6.6	TAPER TENSION CALC / Tension trim input PIN 498	+/-100.00%	0.00%	498
3.6.7	TAPER TENSION CALC / Tapered tension monitor PIN 499	+/-100.00%	0.00%	499
3.7.2	TORQUE COMPENSATOR / Torque demand monitor PIN 500	+/-300.00%	0.00%	500
3.7.3	TORQUE COMPENSATOR / Torque trim input PIN 501	+/-150.00%	0.00%	501
3.7.4	TORQUE COMPENSATOR / Stiction compensation PIN 502	+/-300.00%	0.00%	502
3.7.5	TORQUE COMPENSATOR / Stiction web speed threshold PIN 503	0 - 10.00%	5.00%	503
3.7.6	TORQUE COMPENSATOR / Static friction comp PIN 504	+/-300.00%	0.00%	504
3.7.7	TORQUE COMPENSATOR / Dynamic friction comp PIN 505	+/-300.00%	0.00%	505
3.7.8	TORQUE COMPENSATOR / Friction sign PIN 506	0 - 1	Non-invert	506
3.7.9	TORQUE COMPENSATOR / Fixed mass inertia PIN 507	+/-300.00%	0.00%	507
3.7.10	TORQUE COMPENSATOR / Variable mass inertia PIN 508	+/-300.00%	0.00%	508
3.7.11	TORQUE COMPENSATOR / Material width PIN 509	0 - 200.00%	100.00%	509
3.7.12	TORQUE COMPENSATOR / Accel line speed input PIN 510	+/-105.00%	0.00%	510
3.7.13	TORQUE COMPENSATOR / Accel scaler PIN 511	+/-100.00	10	511
3.7.14	TORQUE COMPENSATOR / Accel input/mon PIN 512	0 -105.00%	0.00%	512
3.7.15	TORQUE COMPENSATOR / Accel filter time constant PIN 513	0 - 200.00 s	0.01 secs	513
3.7.16	TORQUE COMPENSATOR / Tension demand IP PIN 514	+/-100.00%	0.00%	514
3.7.17	TORQUE COMPENSATOR / Tension scaler PIN 515	+/-3.0000	1.0000	515
3.7.18	TORQUE COMPENSATOR / Torque memory select enable PIN 516	0 - 1	Disabled	516
3.7.19	TORQUE COMPENSATOR / Torque memory input PIN 517	+/-300.00%	0.00%	517
3.7.20	TORQUE COMPENSATOR / Tension enable PIN 518	0 - 1	Enabled	518
3.7.21	TORQUE COMPENSATOR / Overwind/underwind PIN 519	0 - 1	Enabled	519
3.7.22	TORQUE COMPENSATOR / Inertia comp monitor PIN 520	+/-300.00%	0.00%	520
				521
				522
3.9.2	PRESET SPEED / Preset speed output monitor PIN 523	+/-300.00%	0.00%	523
3.9.3	PRESET SPEED / Digital input 1 LSB PIN 524	0 - 1	Low	524
3.9.3	PRESET SPEED / Digital input 2 PIN 525	0 - 1	Low	525

Paragraph number	Menu / Description	Range	Default Values	PIN
3.9.3	PRESET SPEED / Digital input 3 MSB PIN 526	0 - 1	Low	526
3.9.4	PRESET SPEED / Value for 000 PIN 527	+/-300.00%	0.00%	527
3.9.4	PRESET SPEED / Value for 001 PIN 528	+/-300.00%	0.00%	528
3.9.4	PRESET SPEED / Value for 010 PIN 529	+/-300.00%	0.00%	529
3.9.4	PRESET SPEED / Value for 011 PIN 530	+/-300.00%	0.00%	530
3.9.4	PRESET SPEED / Value for 100 PIN 531	+/-300.00%	0.00%	531
3.9.4	PRESET SPEED / Value for 101 PIN 532	+/-300.00%	0.00%	532
3.9.4	PRESET SPEED / Value for 110 PIN 533	+/-300.00%	0.00%	533
3.9.4	PRESET SPEED / Value for 111 PIN 534	+/-300.00%	0.00%	534
				535
				536
				537
				538
				539
				540
				541
				542
				543
3.10.2	MULTI-FUNCTION 1 Function mode 1 PIN 544	0 - 6 (1 of 7)	C/O switch	544
3.10.3	MULTI-FUNCTION 1 Output select 1 PIN 545	0 - 1	Disabled	545
3.10.2	MULTI-FUNCTION 2 Function mode 2 PIN 546	0 - 6 (1 of 7)	C/O switch	546
3.10.3	MULTI-FUNCTION 2 Output select 2 PIN 547	0 - 1	Disabled	547
3.10.2	MULTI-FUNCTION 3 Function mode 3 PIN 548	0 - 6 (1 of 7)	C/O switch	548
3.10.3	MULTI-FUNCTION 3 Output select 3 PIN 549	0 - 1	Disabled	549
3.10.2	MULTI-FUNCTION 4 Function mode 4 PIN 550	0 - 6 (1 of 7)	C/O switch	550
3.10.3	MULTI-FUNCTION 4 Output select 4 PIN 551	0 - 1	Disabled	551
3.10.2	MULTI-FUNCTION 5 Function mode 5 PIN 552	0 - 6 (1 of 7)	C/O switch	552
3.10.3	MULTI-FUNCTION 5 Output select 5 PIN 553	0 - 1	Disabled	553
3.10.2	MULTI-FUNCTION 6 Function mode 6 PIN 554	0 - 6 (1 of 7)	C/O switch	554
3.10.3	MULTI-FUNCTION 6 Output select 6 PIN 555	0 - 1	Disabled	555
3.10.2	MULTI-FUNCTION 7 Function mode 7 PIN 556	0 - 6 (1 of 7)	C/O switch	556
3.10.3	MULTI-FUNCTION 7 Output select 7 PIN 557	0 - 1	Disabled	557
3.10.2	MULTI-FUNCTION 8 Function mode 8 PIN 558	0 - 6 (1 of 7)	C/O switch	558
3.10.3	MULTI-FUNCTION 8 Output select 8 PIN 559	0 - 1	Disabled	559
3.11.2	LATCH / Latch output monitor PIN 561	+/-300.00%	0.00%	560
3.11.3	LATCH / Latch data input PIN 561	0 - 1	Low	561
3.11.4	LATCH / Latch clock input PIN 562	0 - 1	Low	562
3.11.5	LATCH / Latch set input PIN 563	0 - 1	Low	563
3.11.6	LATCH / Latch reset input PIN 564	0 - 1	Low	564
3.11.7	LATCH / Latch value for high output PIN 565	+/-300.00%	0.01%	565
3.11.7	LATCH / Latch value for low output PIN 566	+/-300.00%	0.00%	566
			0	567
3.12.2	FILTER 1 / Filter1 output monitor PIN 568	+/-315.00%	0.00%	568
3.12.3	FILTER 1 / Filter1 time constant PIN 569	0 - 32.000 s	1.0 secs	569
				570
				571
				572
3.12.2	FILTER 2 / Filter2 output monitor PIN 573	+/-315.00%	0.00%	573
3.12.3	FILTER 2 / Filter2 time constant PIN 574	0 - 32.000 s	1.0 secs	574
				575
				576
				577
3.13.2	BATCH COUNTER / Counter value monitor PIN 578	0 - 32000	0	578
3.13.3	BATCH COUNTER / Clock input PIN 579	0 - 1	Low	579
3.13.4	BATCH COUNTER / Reset enable input PIN 580	0 - 1	Low	580
3.13.5	BATCH COUNTER / Counter target number PIN 581	0 - 32000	32000	581
3.13.6	BATCH COUNTER / Count > = than target flag PIN 582	0 - 1	Low	582
3.14.2	INTERVAL TIMER / Time elapsed monitor PIN 583	0.1 - 600.0 s	0.0 secs	583

	3.14.3	INTERVAL TIMER / Timer reset enable input PIN 584	0 - 1	Disabled	584
	3.14.4	INTERVAL TIMER / Timer interval PIN 585	0.1 - 600.0 s	5.0 secs	585
	3.14.5	INTERVAL TIMER / Timer expired flag PIN 586	0 - 1	Low	586
					587
	3.15.2	COMPARATOR 1 / Input 1 PIN 588	+/-300.00%	0.00%	588
	3.15.3	COMPARATOR 1 / Input 2 PIN 589	+/-300.00%	0.00%	588
	3.15.4	COMPARATOR 1 / Window mode select PIN 590	0 - 1	Disabled	590
	3.15.5	COMPARATOR 1 / Hysteresis PIN 591	0 - 10.00%	0.00%	591
	3.15.2	COMPARATOR 2 / Input 1 PIN 592	+/-300.00%	0.00%	592
	3.15.3	COMPARATOR 2 / Input 2 PIN 593	+/-300.00%	0.00%	593
	3.15.4	COMPARATOR 2 / Window mode select PIN 594	0 - 1	Disabled	594
	3.15.5	COMPARATOR 2 / Hysteresis PIN 595	0 - 10.00%	0.00%	595
	3.15.2	COMPARATOR 3 / Input 1 PIN 596	+/-300.00%	0.00%	596
	3.15.3	COMPARATOR 3 / Input 2 PIN 597	+/-300.00%	0.00%	597
	3.15.4	COMPARATOR 3 / Window mode select PIN 598	0 - 1	Disabled	598
	3.15.5	COMPARATOR 3 / Hysteresis PIN 599	0 - 10.00%	0.00%	599
	3.15.2	COMPARATOR 4 / Input 1 PIN 600	+/-300.00%	0.00%	600
	3.15.3	COMPARATOR 4 / Input 2 PIN 601	+/-300.00%	0.00%	601
	3.15.4	COMPARATOR 4 / Window mode select PIN 602	0 - 1	Disabled	602
	3.15.5	COMPARATOR 4 / Hysteresis PIN 603	0 - 10.00%	0.00%	603
	3.16.2	C/O SWITCH 1 / Control PIN 604	0 - 1	Low	604
	3.16.3	C/O SWITCH 1 / Input HI value PIN 605	+/-300.00%	0.00%	605
	3.16.3	C/O SWITCH 1 / Input LO value PIN 606	+/-300.00%	0.00%	606
	3.16.2	C/O SWITCH 2 / Control PIN 607	0 - 1	Low	607
	3.16.3	C/O SWITCH 2 / Input HI value PIN 608	+/-300.00%	0.00%	608
	3.16.3	C/O SWITCH 2 / Input LO value PIN 609	+/-300.00%	0.00%	609
	3.16.2	C/O SWITCH 3 / Control PIN 610	0 - 1	Low	610
	3.16.3	C/O SWITCH 3 / Input HI value PIN 611	+/-300.00%	0.00%	611
	3.16.3	C/O SWITCH 3 / Input LO value PIN 612	+/-300.00%	0.00%	612
	3.16.2	C/O SWITCH 4 / Control PIN 613	0 - 1	Low	613
	3.16.3	C/O SWITCH 4 / Input HI value PIN 614	+/-300.00%	0.00%	614
	3.16.3	C/O SWITCH 4 / Input LO value PIN 615	+/-300.00%	0.00%	615

5 Index

Batch counter	58	Reel diameter calculator.....	31
General purpose filters 1 and 2.....	56	Simple logical and linear processing.....	45, 51
Latch block.....	54	Summer 1 and 2.....	14
Parameter profile	27	Taper tension calculator.....	35
PID 1 and 2	19	Warning	7, 8, 32
Preset speed block	48	Winding torque compensator.....	31, 38

PIN number tables

The description of every parameter can be located by using the table in chapter 4. They are listed in numeric order under convenient headings. The tables contain a cross reference to each parameter paragraph number.

6 Record of applications manual modifications

Manual Version	Description of change	Reason for change	Paragraph reference	Date	Software version
3.01	Applications manual	First public issue of applications manual		March 31 st 2000	3.01
3.02	Update manual mods record, no product changes	manufacturing rationalisation	N/A	June 2000	3.02
4.00	Add new blocks. Comparators 1 - 4	Improved functionality	3.15	Aug 2000	4.01
4.00	Add new blocks. C/O Switch 1 - 4	Improved functionality	3.16	Aug 2000	4.01
4.01	No functional modifications			Sept 2000	4.01
4.02	No functional modifications			Dec 2000	4.02
4.03	No functional modifications			Feb 2001	4.01
4.05	Hidden PIN 714)IN SLACK FLAG added.	Facilitate the control of 518)TENSION ENABLE	3.7	July 2001	4.05
5.02	No functional modifications	Note about using preset speed PINs as staging posts, and making EXOR gate with Multifunction block.	3.9 3.10.3	Feb 2002	5.02
5.12	No functional modifications	Front page note about PLA unit.		Jan 2003	5.12
5.14	Summer channel 1, 2 sub-total Pin numbers transposed in manual.	Typo correction	3.2	Sept 2004	5.14

7 Record of application blocks bug fixes

Manual Version	Description of change	Reason for change	Paragraph reference	Date	Software version
3.01	Applications manual	First public issue of applications manual		March 2000	3.01
3.02	Applications manual	No changes		June 2000	3.02
4.00	SUMMER 1 Ch1/Ch2 divider and sign	The dividers and signs for Ch1 are transposed with those for Ch2. NOW OK	3.2.3/4/7/8	Sept 2000	4.01
4.01/2/3	No bugs recorded.	See main manual			4.02/3/4
4.05	No bugs recorded.	See main manual		June 2001	4.05 to 5.01
5.02	No bugs recorded.	See main manual		June 2002	5.02
5.15	No bugs recorded.			Nov 09	5.21

This record only applies to application blocks. Please refer also to the product manual for other bug fixes.

8 Changes to product since manual publication

Any new features that affect the existing functioning of the APPLICATIONS BLOCKS in the unit, that have occurred since the publication of the manual, will be recorded here using an attached page.

Bardac Corporation
40 Log Canoe Circle Stevensville MD 21666 USA

International: (410) 604-3400 Toll Free: (888) ON SPEED

Facsimile: (410) 604-3500

Email: info@bardac.com

www.bardac.com

Bardac 
drives